



# *CALIDUR*

Pilot Operating Handbook

RotorSport UK Ltd  
Poplar Farm  
Prolley Moor  
Wentnor  
Bishops Castle  
SY9 5EJ

Company Reg No 5486550

Phone: +44 (0) 1588 505060

Fax: +44 (0) 1588 505060

Email: [info@rotorsport.org](mailto:info@rotorsport.org)

Approval number DAI/9917/06

# **RSUK0060 Pilot's Operating Handbook for the Calidus Gyroplane**

# Flight and Operation Manual for the Calidus Gyroplane

Model: Calidus

Serial number: RSUK/CALS/ \_\_\_\_\_

Registration: G- \_\_\_\_\_

Engine: 914UL or 912ULS serial \_\_\_\_\_

Propeller: HTC 1,73m ground adjustable propeller  
or  
Ivoprop DL3-68 in-flight adjustable propeller

Rotor: Autogyro 8.4m RotorSystem II (red end caps, silver spacers) or  
Autogyro 8.4m RotorSystem II TOPP (blue end caps, silver spacers)  
**Note that the original AAN approved the use of orange end cap rotors. These are no longer in service.**

Aircraft manufacturer and Type Approval holder: RotorSport UK Ltd  
Prolley Moor,  
Wentnor,  
Bishops Castle,  
Shropshire,  
SY9 5EJ

Owner: \_\_\_\_\_  
\_\_\_\_\_  
\_\_\_\_\_

This flight manual is always to be carried on board of the aircraft and must be kept in current, up-to-date status. The latest revisions and version status are available at [www.rotorsport.org](http://www.rotorsport.org). Extent and revision status of the manual is recorded in the revision log and the table of contents.

This gyroplane may be operated only in strict compliance with the limitations and procedures contained in this manual.

**The manual is not a substitute for competent theoretical and practical training on the operation of this aircraft. Failure to adhere to its provisions or to take proper flight instruction can have fatal consequences.**

## REVISION LOG

Rev.	Change summary	Date	Signature
1.0	First formal release	14.01.11	
2.0	Not recorded	12.09.11	
3.0	Starter fuse changed to 100A under MC-192/SB-042 p74, Flymap AHRS unit added p56, p59 (with EASA ref), p60, Flymap AHRS placard p21. Explanation of MC-194/SB-044 Reverse airflow ground cooling system (p45) Section 7 Comment on sunlight and damp storage conditions (p86).	02.04.12	
4.0	Warning on Binx nuts (p38), different rpm gauges (p62), nitrogen-filled tyres (p64) and pressures clarified in Checklist. 5hr greasing added (p39-40), ATR833 audio socket (p76), AI option (p62). Improved pre-rotator gearbox (p44), cooler unblanking highlighted (p91), turbo cooling note (p46), UL91 and Mogas E10 (p18), rotor brake technique (p46), Section 3.15 introduced (p30), Clutch Brake MC260 (p44)	01.07.13	
5.1	Section 9 IVO-prop added (p93-98), info on MC-258 cabin heater on P74 and 84 added.	10.06.14	
6.0	TOPP rotor option added p2,p5,p6,p9,p14,p15,p19,p31,p32,p36, p46,p48	12.4.16	
7.0	Rotorhead III added, MTOW increased, operational ceiling increased. British and German manuals amalgamated.	17.01.19	
Pilots Flight and Operation Manual Document approval			
Signature		Signature	
Position: Flight test CVE		Position: Head of Engineering	

**This document is to approve the release of the AutoGyro Pilots Handbook POH\_CD\_4.0 for use with the Calidus aircraft within the UK market.**

**Within the UK market RotorSport UK Ltd is considered by the UK CAA to be the Manufacturer and the Type Approval holder.**

## Differences to be noted by UK operator owners.

1. The approved aircraft configurations within the UK market are shown in TADS BG04, available from the UK CAA website.
2. The only rotor options permissible are those shown on page 2 and in the TADS.
3. The Approved Operational Limitations are;

### Aerobatic Limitations

Aerobatic manoeuvres are prohibited  
Manoeuvres involving a deliberate reduction in normal 'g' shall be avoided

### Loading Limitations

Maximum Total Weight Authorised:	500kg or 560Kg (914UL engines only, from aircraft serial no. RSUK/CALS/037)
Maximum Empty Weight	311.6 kg (914UL at 500Kg MTOW) 371.6Kg (914UL at 560Kg MTOW) 309Kg (912ULS, 500Kg MTOW)
Maximum Pilot Weight front seat	125 kg
Minimum Pilot Weight front seat	65 kg
Maximum Occupant Weight rear seat	120 kg
Front seat occupants under 65 kg in weight must carry suitable ballast	

### Engine Limitations

Maximum take-off (max. 5 minutes)	5800 rpm
Max. continuous	5500 rpm
Max. CHT	135°C
Max CT (where fitted)	120 °C
Min. oil temp.	50°C
Max. oil temp.	130°C
Min. oil pressure	0.8 bar
Normal operating range	2-5bar
Max. oil pressure	7 bar

### Air Speed Limitations

Maximum indicated air speed (IAS) 90 mph, or 120mph if SB-039 incorporated, or 120mph if SB-039 incorporated and Rotor System II TOPP rotor variant fitted (blue end caps)

### Other Limitations

The aircraft shall be flown by day in Visual Meteorological Conditions only.  
Flight in icing conditions is prohibited (not placarded)  
Flight in strong gusty winds or wind velocities of more than 45mph (40 kts) is prohibited. (not placarded)

### Manoeuvre Limitations

Aerobatic manoeuvres are prohibited.

Manoeuvres involving a deliberate reduction in normal 'g' shall be avoided.

Maximum bank angle 60 degrees from vertical

### Cross-wind Limitations

The maximum cross-wind component for takeoff is 22kts.

Landing should always be made into wind where practical. The maximum landing crosswind 15kts.

## **The aircraft operator is reminded to read the aircraft CAA Operational Limitations (part of the Permit to Fly) the aircraft specific limitations of operation.**

4. The legal basis for the operation of this CALIDUS autogyro is regulated in the Airworthiness Approval Notification (AAN29266), issued by the UK Civil Aviation Authority (CAA). It has been shown to comply with the requirements of BCAR Section T issue 3 (and issue 5 where appropriate), and is considered as a factory built aircraft. Reference must be made to the Permit to Fly limitations issued by the CAA for each individual aircraft.

5. The CG limits approved during the aircraft UK type approval are 485 to 255mm forward of the mainwheel datum, and 795 to 895mm above the CG datum (the mainwheel axle is the 0 CG datum in x and z). These limits are unchanged when MC-385 "Calidus upgrade to 560kg MTOW" is embodied.

Remember - Fuel loading permissible is 500kg minus occupant weight, minus aircraft empty weight, minus any baggage or items added to the aircraft since weighed. Aircraft empty weight is placarded. Mogas nominal density is 0.72kg/ltr (check for the type of fuel used).

Example: 500Kg – 275Kg (empty wt) – 90Kg (rear seat occupant) – 90Kg (pilot) – 10Kg (rear seat luggage) = 35Kg. Useful fuel load (assuming both fuel tanks fitted) is  $35/0.72 = 48.6$ ltrs.

Maximum possible fuel load (assuming both fuel tanks fitted) is 75ltrs, 54Kg

If ballast is required to meet the minimum front seat loading condition of 65Kg, then it should be in the form of thin lead sheet placed behind and under the pilot seat cushion.

Carrying of bags or other items inside the aircraft is possible, due to the design of the inside construction covering the control cables and linkages.

WARNING! If carried, ensure there is no control obstruction! Bags fitted into the rear seat must be securely attached to the seat harness, and included in the weight/balance calculation.

This is especially important with an open canopy, take care that items inside the cockpit do not get blown out!

6. Approved panel layout at the time of writing are; Day VFR UK, Ipad, and Garmin G3X.

7. Aircraft equipped with rotorhead III are permitted to have an increased altitude ceiling of 12,000ft and MTOW increase to 560Kg.

8. Propellers: HTC 3 blade. Pitch angle: 20.5deg 912ULS, 22deg 914UL (ground adjustable to suit engine and working environment). Take account of the propeller concave

face whilst measuring (see Maint. Manual RSUK0061). Propeller is pitched for max ground rpm of 5500.

For the Ivoprop DL3-68, refer to manual RSUK0325.

## 9. GENERAL PLACARDS AND MARKINGS:

In conformity with BCAR Section T the following placards and markings are installed:

- All emergency controls are coloured red.
- All cockpit controls are clearly marked as to their function and method of operation.
- Fuel and oil filler openings are clearly marked, together with the grade or type required.
- Fuel tank capacity is clearly marked.
- Loading conditions are clearly marked as follows:

Loading conditions. This may indicate an MTOW of 500 or 560Kg

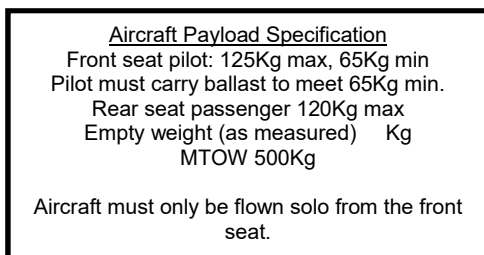

Throttle, choke and brake control marking

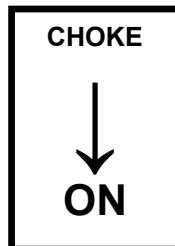
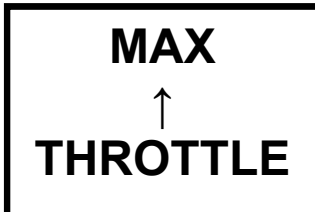
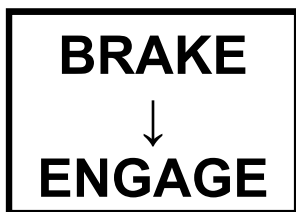

Limitations if fitted with orange end-cap rotor system

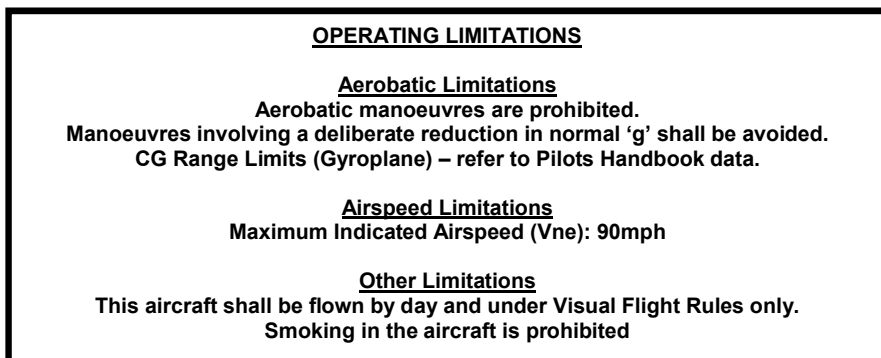

Limitations if fitted with red end-cap RotorSystemII under SB-039, or SB-039 is embodied and RotorSystem II TOPP variant is fitted (blue end caps)

**OPERATING LIMITATIONS**

**Aerobatic Limitations**

**Aerobatic manoeuvres are prohibited.  
Manoeuvres involving a deliberate reduction in normal 'g' shall be avoided.  
CG Range Limits (Gyroplane) – refer to Pilots Handbook data.**

**Airspeed Limitations**

**Maximum Indicated Airspeed (Vne): 120mph**

**Other Limitations**

**This aircraft shall be flown by day and under Visual Flight Rules only.  
Smoking in the aircraft is prohibited**

Occupant warning (in front and rear cockpits)

Fitted beside front

seat and back of front seat

**OCCUPANT WARNING**

**This aircraft has not been certificated to an  
International Requirement**

Front seat back  
straps limit stops  
must be fitted if rear  
stick is fitted

Auxiliary socket (where fitted,  
marked '12v 5A on the panel)

Roll trim indicator (where fitted)

L  R  
Roll Trim

Coolant header tank

Engine oil tank

**Coolant Header Tank.  
Filled with 50/50  
water/antifreeze**

**Oil tank  
Capacity 3 ltrs.  
Use Shell VSX or  
equivalent Motorcycle  
oil SF or SG**



Alternative header tank and oil tank placard;

**COOLANT HEADER  
TANK:**  
Replenish with 50 / 50  
Ethylene Glycol antifreeze  
and distilled water

**ENGINE OIL:**  
Capacity 3.4 ltr.  
AEROSHELL OIL SPORT  
PLUS 4 or equivalent in  
accordance with BRP Rotax  
service instructions

Fuel tank beside the filler neck (shows 39ltrs capacity if only one tank installed).

**Fuel capacity: 75 ltrs  
Preferred fuel:  
EN228 MOGAS super or super plus  
(AVGAS 100LL permissible)**

Low voltage placard mounted on instrument panel.

**Continuously lit Low Volt lamp indicates  
electrical demand exceeds supply, and  
the battery is being drained. If lit in flight,  
reduce demand until unlit. If not possible,  
expedite landing.**

Warning lamp placards. (where not annotated on panel)

Canopy  
unlocked

Pressure gauge placard  
(unless panel annotated)

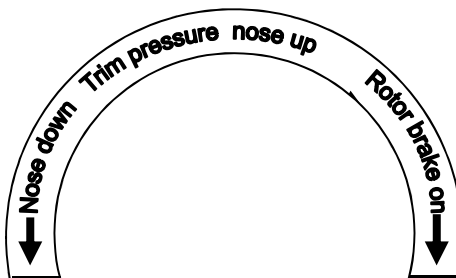

Luggage lockers 2Kg max

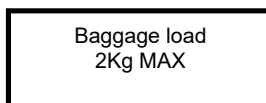

Removable map bag  
(where fitted) 1Kg max

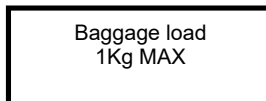

Static ports – ring around saying 'Static Port – do not obstruct!'

Canopy handle 'Ensure locked down before flight!'

On top of control stick (either type of stick grip)

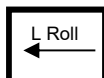
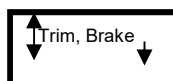
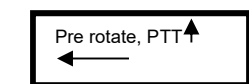

(L roll and R Roll only if roll-trim system fitted)

Fuel cut-off valve

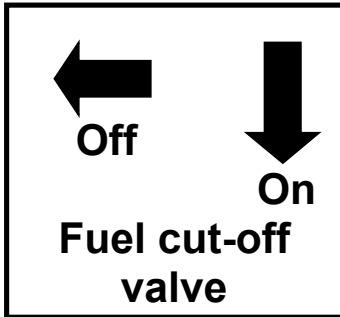

Interlock placard (unless engraved on panel)



Placard above switch, where fitted, for Airbox GPS (adjacent to 'Nav' sw). 'Off' placard is fitted below the switch.



Where a Flymap L GPS has been fitted with an AHRS unit, the following placard must be affixed adjacent to the Flymap GPS.

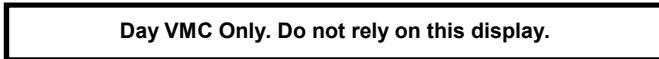

Instructor pack (where fitted). Brake placard only where brake is fitted.

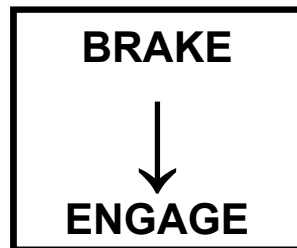
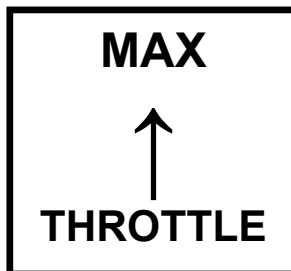
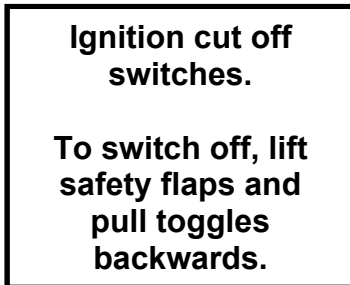

- Other

If the compass deviation is more than 5° on all headings, then a deviation placard must be present.

COMPASS DEVIATION			
For	N	30	60
Set			
For	E	120	150
Set			
For	S	210	240
Set			
For	W	300	330
Set			
Calibration by:		date:	

GPS placard (where a GPS is fitted)  
(Placard may be a different shape)

GPS unit not for navigational use. The unit, software & charts are not approved or certified to any national standard. Warning! Charts or software may not be up to date.

Canopy placards for the operating lever  
Inside Outside

Lift handle to unlock canopy. Ensure locked down before flight!

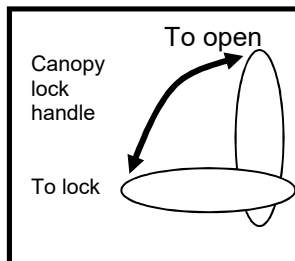

Alternative similar placards are acceptable.

Instrument placards as section 2.5

The aircraft is fitted with a permanently attached fireproof plate with the aircraft registration number and serial no. marked on it, on front of the instrument panel.

The registration letters are placed high on the tail fin, and are 60cm long, 30cm high. This has been accepted as best practice compliance to CAP523, the CAA standard for aircraft registration. Alternative markings and position of markings is acceptable provided they comply with this standard.

Note that all placards must have the same units of measure as the instruments.

If an IVO-prop in-flight variable pitch propeller is fitted in combination with a 914UL turbocharged engine the following placard is fitted adjacent to the manifold pressure gauge or combined engine rpm/manifold pressure gauge, as applicable.

Max manifold pressure (take off):	39.9in Hg Max
continuous manifold pressure:	35.4in Hg

<p style="text-align: center;">ENGINE RPM LIMITS MAX CONTINUOUS <b>5,500</b> MAXIMUM <b>5.800</b></p>
---

AAN29345 releases.

AAN and addendum	Purpose of release and comment
AAN29266	Original aircraft approval with 912ULS and 914UL engines, HTC propeller and 8.4m rotorsystem. Vne restricted to 90mph (from 120mph)
Addendum 1	Vne restriction removed with fitment of RotorSystem II red end cap version. All UK Calidus were upgraded to this rotorsystem.
Addendum 2	Release of the fitment of in-flight pitch adjustable DL3-68 Ivoprop propeller and max empty weight increase.
Addendum 3	Rotorsystem II TOPP (blue end caps) approved for use
Addendum 4	Release of the 914 engined aircraft at 560Kg MTOW (Rotorhead III version). Increase of maximum altitude to 12,000ft.

**Note!**

**It is the pilot/operators responsibility to operate the Calidus aircraft within the Permit Limitations issued by the UK Civil Aviation Authority issued for the aircraft, regardless of permitted limits within the AAN and associated Addendums above.**

## APPENDIX

### LIST OF APPENDICES

Operator Registration Form

Ownership change form

<p>This form is supplied to enable the new owner to register the change of ownership, so that he/she may receive any service or other information relating to the aircraft. The information is stored on a computer, and is only used within RotorSport Sales and Service Ltd for the above purpose.</p> <p>If the new owner does not register, then they will not be automatically updated, which may lead to unsafe flight or an un-airworthy aircraft.</p> <p>Return this form by email to;  <a href="mailto:info@rotorsport.org">info@rotorsport.org</a></p>		
Aircraft type	Aircraft serial No.	
Aircraft Registration No.	Aircraft Engine No.	
Logbook Aircraft hours	Logbook Engine hours	
<p>Old owners name and address</p> <div style="border: 1px solid black; width: 100%; height: 100px; margin-top: 10px;"></div> <div style="border: 1px solid black; width: 30%; margin-left: auto; margin-top: 10px; padding: 5px;"> <p>Signature &amp; date</p> </div>		
<p>New owners name and address</p> <div style="border: 1px solid black; width: 100%; height: 100px; margin-top: 10px;"></div> <p>Email:</p> <div style="border: 1px solid black; width: 30%; margin-left: auto; margin-top: 10px; padding: 5px;"> <p>Signature &amp; date</p> </div>		
<b>RSS Office use only</b>		
Date entered onto database	Acknowledgement sent (date)	Job completed by:

# **Pilot Operating Handbook for Gyroplane Calidus**



All rights reserved. Under the copyright laws, this manual may not be copied, in whole or in part, without the written consent of AutoGyro GmbH. AutoGyro reserves the right to change or improve its products and to make changes in the content of this manual without obligation to notify any person or organisation of such changes or improvements. Notifications to the Civil Aviation Authorities or other organisations based on legal regulations are unaffected.

MTOsport, Calidus, Cavalon, the AutoGyro logo and word picture mark are trademarks or registered trademarks of AutoGyro AG, registered in Germany and other countries.

Other company and product names mentioned herein may be trademarks of their respective companies. Mention of third-party products is for informational purposes only and constitutes neither an endorsement nor a recommendation. AutoGyro assumes no responsibility with regard to the performance or use of these products. All understandings, agreements, or warranties, if any, take place directly between the vendors and the prospective users.

U.S. and foreign patents of AutoGyro AG are used in the Calidus and Cavalon gyroplanes - (US.Pat.No. 8,690,100; US.Pat.No. D699,153)

Every effort has been made to ensure that the information in this manual is accurate. AutoGyro GmbH is not responsible for printing or clerical errors.

# Pilot Operating Handbook for Gyroplane Calidus

Model: \_\_\_\_\_

Serial number: \_\_\_\_\_

Registration: \_\_\_\_\_

Type certificate number: \_\_\_\_\_

Aircraft manufacturer and  
type certificate holder:

AutoGyro GmbH  
Dornierstraße 14  
D-31137 Hildesheim  
Tel.: +49 (0) 51 21 / 8 80 56-00  
Fax: +49 (0) 51 21 / 8 80 56-19

Distribution partner: \_\_\_\_\_

\_\_\_\_\_  
\_\_\_\_\_

Owner: \_\_\_\_\_

\_\_\_\_\_  
\_\_\_\_\_

This flight manual is always to be carried on board of the aircraft and must be kept in current, up-to-date status. The latest revisions and version status is available at [www.auto-gyro.com](http://www.auto-gyro.com). Extent and revision status of the manual is recorded in the revision log and the table of content.

This gyroplane may be operated only in strict compliance with the limitations and procedures contained in this manual.

**The manual is not a substitute for competent theoretical and practical training on the operation of this aircraft. Failure to adhere to its provisions or to take proper flight instruction can have fatal consequences.**

## **Applicability**

This manual is applicable for all Calidus models.



## CONTENTS

SECTION 1 - GENERAL.....	1-1
1.1 Introduction.....	1-1
1.2 Certification .....	1-1
1.3 Performance Data and Operating Procedures .....	1-1
1.4 Definition of Terms .....	1-2
1.5 Important Note.....	1-2
1.6 Three-view of the Calidus .....	1-3
1.7 Description .....	1-4
1.8 Technical Data .....	1-4
1.9 Rotor .....	1-4
1.10 Engine.....	1-5
1.11 Propeller.....	1-5
1.12 Unit Conversion.....	1-6
1.13 Abbreviations and Terminology .....	1-7
SECTION 2 - LIMITATIONS .....	2-1
2.1 General .....	2-1
2.2 Environmental Limitations.....	2-2
2.3 Colour Code for Instrument Markings .....	2-3
2.4 Airspeed Limitations and Instrument Markings.....	2-4
2.5 Rotor Speed Limitations and Instrument Markings.....	2-4
2.6 Power Plant Limitations and Instrument Markings.....	2-5
2.7 Weight and Balance .....	2-7
2.8 Flight Crew .....	2-8
2.9 Kinds of Operation.....	2-8
2.10 Fuel.....	2-9
2.11 Minimum Equipment.....	2-10
2.12 Placards .....	2-11
SECTION 3 - EMERGENCY PROCEDURES .....	3-1
3.1 Engine Failure .....	3-1
3.2 Air Restart Procedure .....	3-2
3.3 Landing into Trees or High Vegetation.....	3-2
3.4 Degradation of Engine Power.....	3-3
3.5 Evacuating the Aircraft.....	3-3
3.6 Smoke and Fire .....	3-3
3.7 Canopy Open in Flight .....	3-4
3.8 Off-field Landing .....	3-4
3.9 Flight Control Malfunction .....	3-5
3.13 Warning Lights .....	3-8
3.14 Parameters out of Limits.....	3-11
3.15 Additional Cockpit Indications.....	3-12
3.16 Loss of Visibility.....	3-12



3.17	Recovery System / Rotor System .....	3-12
3.18	Rotor Icing .....	3-12
3.19	Landing with a Deflated Tyre .....	3-13
3.20	Failure of Variable Pitch Propeller (if installed) See also Section 9 .....	3-13
3.21	Alternative Method of Engine Shut-down .....	3-14
3.22	Emergency exit after an aircraft roll over .....	3-14
SECTION 4	- NORMAL PROCEDURES .....	4-1
4.1	Airspeeds for Safe Operation .....	4-1
4.2	Preparation for Flight .....	4-1
4.3	Daily or Pre-flight Checks .....	4-1
4.4	Before Boarding .....	4-5
4.5	Before Starting Engine .....	4-5
4.6	Starting Engine .....	4-5
4.7	Taxi and Run-up .....	4-6
4.8	Take-off Procedure .....	4-7
4.9	Take-off Run .....	4-9
4.10	Climb .....	4-10
4.11	Cruise .....	4-10
4.12	Descent .....	4-10
4.13	Approach .....	4-10
4.14	Landing .....	4-11
4.15	Go-around .....	4-12
4.16	After Landing .....	4-12
4.17	Engine Shut-down .....	4-13
4.18	Parking .....	4-13
4.19	Special Procedure: Short Field Take-off .....	4-14
4.20	Special Procedure: Slow Speed Sink and Recovery .....	4-15
4.21	Flight under Conditions of Precipitation .....	4-16
4.22	Flight with Summer Canopy .....	4-16
4.23	Engine In-flight Shut-down and Air Restart .....	4-16
4.24	Noise Abatement .....	4-17
SECTION 5	- PERFORMANCE .....	5-1
5.1	Demonstrated Operating Temperature .....	5-1
5.2	Airspeed Correction .....	5-1
5.3	Height-Velocity Diagram .....	5-2
5.4	Speeds .....	5-3
5.5	Rate of Climb .....	5-4
5.6	Take-off and Landing Data .....	5-4
5.7	Influence on Take-off Distance and Climb Rate .....	5-5
5.8	Sink Rate and Glide Ratio .....	5-8
5.9	Additional Performance Data .....	5-8
5.10	Sound Exposure Level / Noise Characteristics .....	5-9
5.11	High Altitude Operation .....	5-9
SECTION 6	- WEIGHT AND BALANCE .....	6-1



6.1	General .....	6-1
6.2	Weight and Balance Record .....	6-1
6.3	Compliance with Weight and Balance .....	6-1
SECTION 7 - SYSTEM DESCRIPTION .....		7-1
7.1	Introduction.....	7-1
7.2	Airframe and Undercarriage.....	7-1
7.3	Doors, Windows and Exits.....	7-1
7.4	Fuel System .....	7-1
7.5	Pneumatic System.....	7-4
7.6	Power Plant.....	7-5
7.7	Propeller.....	7-6
7.8	Rotor System.....	7-7
7.9	Vibration Damping.....	7-10
7.10	Flight Controls .....	7-11
7.11	Electrical System.....	7-17
7.12	Lighting System.....	7-18
7.13	Avionics.....	7-18
7.14	Instrument Panel .....	7-18
7.15	Intercom .....	7-25
7.16	Pitot Static.....	7-25
7.17	Indicators and Sensors.....	7-25
7.18	Seats and Seatbelts .....	7-26
7.19	Stowage Capacity.....	7-27
7.20	Fire Warning System .....	7-27
7.21	Fuses .....	7-27
7.22	Cabin heater.....	7-30
SECTION 8 - HANDLING AND SERVICING.....		8-1
8.1	Maintenance Obligations .....	8-1
8.2	General .....	8-1
8.3	Ground Handling .....	8-2
8.4	Cleaning .....	8-2
8.5	Refuelling .....	8-2
8.6	Checking of Engine Oil Level.....	8-3
8.7	Checking of Engine Coolant Level.....	8-3
8.8	Tire Pressure.....	8-3
8.9	Lubrication and Greasing.....	8-4
8.10	Replenishing of Fluids .....	8-4
8.11	Engine Air Filter.....	8-5
8.12	Propeller.....	8-5
8.13	Battery.....	8-5
8.14	Winter Operation .....	8-6
8.15	Removal, Disassembly, Assembly and Installation of the Rotor .....	8-7
8.16	Road Transport .....	8-11
8.17	Repairs.....	8-12



SECTION 9 - SUPPLEMENTS .....	9-i
9-1 Variable Pitch Propeller - IVO .....	1
9-1.1 General .....	1
9-1.2 Limitations.....	1
9-1.3 Emergency Procedures.....	1
9-1.4 Normal Procedures .....	1
9-1.5 Performance .....	3
9-1.6 Weight and Balance .....	4
9-1.7 System Description .....	4
9-1.8 Handling and Servicing .....	7
9-2 Lights .....	1
9-2.1 General .....	1
9-2.2 Limitations.....	1
9-2.3 Emergency Procedures.....	1
9-2.4 Normal Procedures .....	1
9-2.5 Performance .....	1
9-2.6 Weight and Balance .....	1
9-2.7 System Description .....	1
9-2.8 Handling and Servicing .....	2
9-3 GPS/Moving Map Systems.....	1
9-3.1 General .....	1
9-3.2 through 9-3.6 .....	1
9-3.7 System Description .....	1
9-3.8 Handling and Servicing .....	1
9-4 Fire Indication.....	1
9-4.1 General .....	1
9-4.2 Limitations.....	1
9-4.3 Emergency Procedures.....	1
9-4.4 through 9-4.9 .....	1
9-5 Canopy Indication.....	1
9-5.1 General .....	1
9-5.2 Limitations.....	1
9-5.3 Emergency Procedures.....	1
9-5.4 through 9-5.6 .....	1
9-5.7 System Description .....	1
9-5.8 Handling and Servicing .....	1
9-6 Stowage Compartment.....	1
9-7 ELT (Emergency Locator Transmitter).....	1
9-7.1 General .....	1
9-7.2 Limitations.....	1
9-7.3 Emergency Procedures.....	1
9-7.4 Normal Procedures .....	1
9-7.5 through 9-7.6 .....	1
9-7.7 System Description .....	1
9-7.8 Handling and Servicing .....	2



9-8 Removal/Installation Canopy .....	1
9-8.1 General .....	1
9-8.2 Limitations .....	1
9-8.3 Emergency Procedures .....	2
9-8.4 Normal Procedures.....	2
9-8.5 Performance.....	2
9-8.6 Weight and Balance .....	2
9-8.7 System Description.....	2
9-8.8 Handling and Servicing.....	2
SECTION 10 - SAFETY TIPS .....	10-1
Low-G Avoidance.....	10-1
Side Slip in Gyroplanes.....	10-1
Flying Low on Fuel Is Dangerous .....	10-2
Do Not Push the Envelope and Remain Easy On the Controls.....	10-2
Strobe Lights On – For Your Own and Other’s Safety .....	10-2
Propellers and Rotors Can Be Extremely Dangerous .....	10-2
Power Lines and Cables Are Deadly .....	10-2
Loss of Visibility Can Be Fatal .....	10-2
Overconfidence Prevails in Accidents .....	10-3
Flying Low over Water is Very Hazardous .....	10-3
Conversion Pilots Constitute High Risk When Flying Gyroplanes .....	10-3
Beware of Demonstration or Initial Training Flights .....	10-4
Training Off-Field Simulated Engine Failures .....	10-4
APPENDIX .....	10-1
Operator Registration Form	
Customer Feedback Form	
Incident Reporting Form	





## LIST OF EFFECTIVE PAGES

Page(s)	Rev.	Date
1-1 to 1-8	4.0	17.JAN.2019
2-1 to 2-12	4.0	17.JAN.2019
3-1 to 3-10	4.0	17.JAN.2019
4-1 to 4-16	4.0	17.JAN.2019
5-1 to 5-6	4.0	17.JAN.2019
6-1 to 6-2	4.0	17.JAN.2019
7-1 to 7-14	4.0	17.JAN.2019
8-1 to 8-10	4.0	17.JAN.2019
9-1 - 1 to 4	4.0	17.JAN.2019

Page(s)	Rev.	Date
9-2 – 1 to 2	4.0	17.JAN.2019
9-3 - 1 to 2	4.0	17.JAN.2019
9-4 - 1 to 2	4.0	17.JAN.2019
9-5 - 1 to 2	4.0	17.JAN.2019
9-6 – 1 to 2	4.0	17.JAN.2019
9-7 – 1 to 2	4.0	17.JAN.2019
9-8 – 1 to 2	4.0	17.JAN.2019
10-1 to 10-4	4.0	17.JAN.2019

## CONTENTS

1.1	Introduction.....	1-1
1.2	Certification .....	1-1
1.3	Performance Data and Operating Procedures .....	1-1
1.4	Definition of Terms .....	1-2
1.5	Important Note.....	1-2
1.6	Three-view of the Calidus .....	1-3
1.7	Description .....	1-4
1.8	Technical Data .....	1-4
1.9	Rotor .....	1-4
1.10	Engine .....	1-5
1.11	Propeller.....	1-5
1.12	Unit Conversion.....	1-6
1.13	Abbreviations and Terminology .....	1-7

INTENTIONALLY LEFT BLANK

## SECTION 1 - GENERAL

### 1.1 Introduction

This manual is designed as an operating guide for pilots, instructors, and owners/operators, providing information for the safe and efficient operation of this gyroplane. It includes material required to be furnished to the pilot by the competent certification authority. However, this handbook is not designed as a substitute for adequate and competent flight instruction.

Pilots of this aircraft must hold a proper license including the class rating 'gyroplane', corresponding to the aircraft's registration. A special endorsement may be required to fly with passengers. It is the pilot's responsibility to be familiar with this handbook, the special characteristics of this gyroplane, and all other information and legal requirements relevant for the operation in his country. The pilot is responsible to determine the gyroplane is safe for flight, and to operate the aircraft with respect to the procedures and limitations provided in this manual.

It is the owner's/operator's responsibility to have this gyroplane registered and insured, according to country-specific regulations. The aircraft owner/operator is also responsible for maintaining the gyroplane in airworthy condition. Maintenance instructions are provided in the Maintenance Manual and in SECTION 8 of this manual. Note that depending on the kind of operation, type of maintenance activity, or component involved, the competent authority may dictate qualified personnel and/or respective facilities.

### 1.2 Certification

The Calidus is designed, tested and certified according to the German design specifications for microlight gyroplanes ("Bauvorschriften für Ultraleichte Tragschrauber", BUT 2001) including its latest amendment published in "Nachrichten für Luftfahrer" NfL II 13/09 issued 12.02.2009, as well as the British Civil Airworthiness Requirements (BCAR) Section T.

The corresponding certification documents (Geräte-Kennblatt) have been issued by the responsible Germany department DULV (Deutscher Ultraleichtflugverband e.V.), respectively the German national certifying authority.

The noise certificate was granted according to the German requirements for noise protection for microlight gyroplanes ("Lärmschutzverordnung für Ultraleichte Tragschrauber").

### 1.3 Performance Data and Operating Procedures

The legal basis for operating a gyroplane is provided by national law and its respective regulations. The instructions and conditions contained have to be considered when operating the gyroplane. **In addition the gyroplane must be operated in compliance with the technical specifications and limitations from the national approval (e.g. Type Approval Data Sheet).**

All documented performance data and operating procedures have been identified within the certification processes for this gyroplane by means of flight test and analysis.

## 1.4 Definition of Terms

This manual uses **WARNINGS**, **CAUTIONs** and **NOTEs** in bold capital letters to indicate especially critical and important instructions. Additionally, the colour of the panel (red, yellow, and grey shading) highlights the significance of the instruction. Definitions for each term are given below.

### WARNING

**A warning means that the neglect of the appropriate procedure or condition could result in personal injury or loss of life.**

### CAUTION

**A caution means that the neglect of the appropriate procedure or condition could result in damage to or destruction of equipment.**

### NOTE

**A note stresses the attention for a special circumstance, which is essential to emphasize.**

## 1.5 Important Note

Before each flight pilots must make themselves familiar with the appropriate navigational, weather and safety information pertinent to their planned route.

The limitations provided in SECTION 2 of this manual must be respected at all times. Check the manufacturer's web site [www.auto-gyro.com](http://www.auto-gyro.com) regularly for flight manual updates, airworthiness directives, service bulletins, or safety information.

Abrupt manoeuvres or flight in heavy turbulence must be avoided as this could lead to rotor speed variations associated with high stress, possible damage to the aircraft, or uncontrollable attitudes.

### 1.6 Three-view of the Calidus

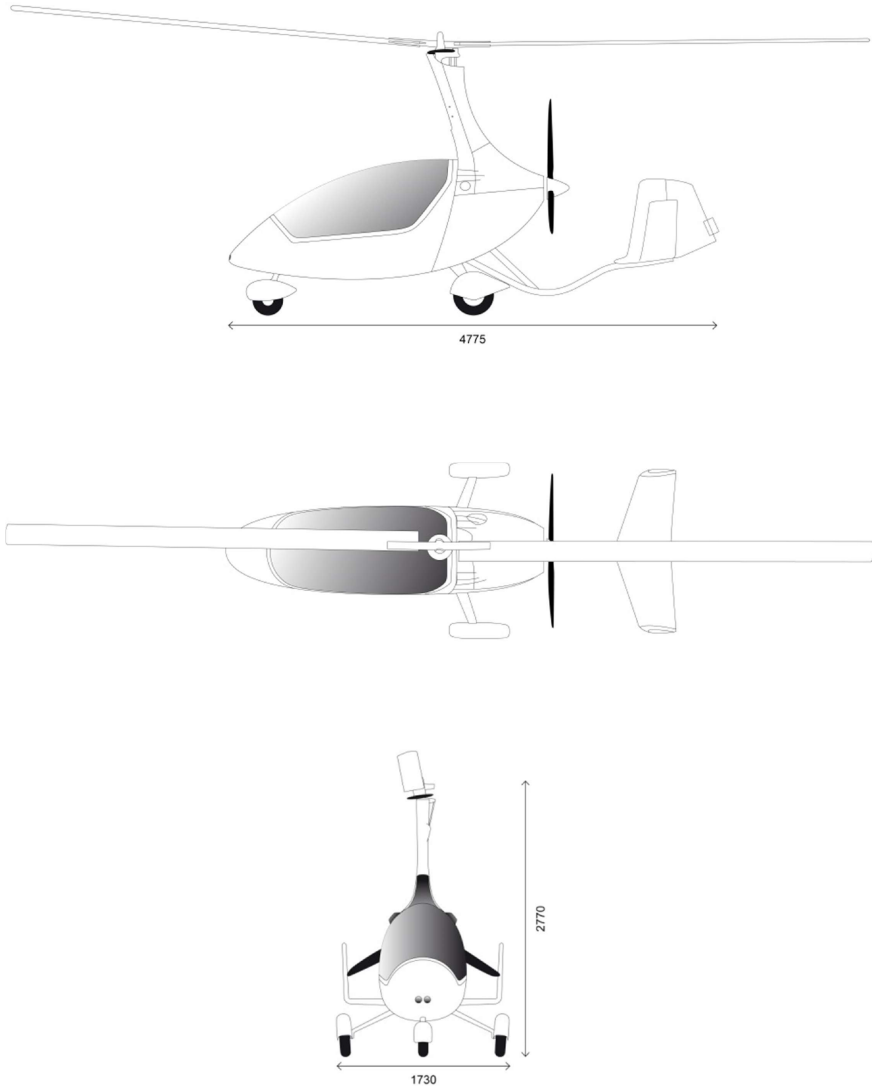

## 1.7 Description

### General Characteristics

- Gyroplane with nose gear wheel chassis
- Framework manufactured from inert-gas welded stainless steel tube
- Front aircraft structure is a GRP/CRP monocoque bolted to the airframe
- Two-seat tandem configuration (monocoque design)
- Main landing gear with GRP (glass fibre reinforced plastic) spring spar and hydraulic disc brakes
- Extruded aluminium rotor
- Rotor head controlled with push-pull control cables
- Rudder controlled with cables
- Rudder and stabilizer surfaces made of GRP (or carbon fibre)

## 1.8 Technical Data

Length: .....	4.78 m
Width: .....	1.73 m
Height: .....	2.77 m
Empty weight: .....	262.0 kg
Payload: .....	188.0 kg/depends on MTOW
Take-off weight/mass (max.):.....	450 kg / 500 kg / 560 kg <sup>1</sup>
Fuel tank capacity: .....	39 ltr
(with optional auxiliary fuel tank installed) .....	75 ltr

## 1.9 Rotor

### General (Standard Rotor RSI (orange end cap), RSII (red end cap) or RSII TOPP (blue end cap))

Type: .....	2-bladed, fixed pitch, free to teeter
Material: .....	EN AW 6005A T6 aluminium extrusion
Blade profile: .....	NACA 8H12
Rotor diameter.....	8.4 m
Rotor disc area .....	55.4 sqm
Rotor disc load (at 450 / 500 / 560kg MTOW).....	8.1 / 9.1 / 10.1 kg/sqm

<sup>1</sup> See Type Approval Data Sheet

## 1.10 Engine

### ROTAX 912 ULS

- 4-cylinder, four-stroke spark-ignition engine with opposed cylinders
- Liquid cooled cylinder heads
- Air cooled cylinders
- Dry sump forced lubrication with separate oil tank
- Automatic adjustment by hydraulic valve tappet
- 2 carburetors
- Mechanical fuel pump
- Electronic dual ignition
- Propeller speed reduction unit, engine mount assembly
- Electric starter (12V 0.6kW)
- Air intake system, exhaust system
- Slipper clutch

### ROTAX 914 UL

- 4-cylinder, four-stroke spark-ignition engine with opposed cylinders with turbo charger
- Liquid cooled cylinder heads
- Air cooled cylinders
- Dry sump forced lubrication with separate oil tank
- Automatic adjustment by hydraulic valve tappet
- 2 carburetors
- Electronic dual ignition
- Propeller speed reduction unit, engine mount assembly
- Electric starter (12V 0.6kW)
- Air intake system, exhaust system
- Slipper clutch

## 1.11 Propeller

### HTC 3 Blade

Airscrew with ground adjustable pitch made of CRP / GRP

Model ..... HTC 3 Blade 172 ccw 3B  
 Number of blades ..... 3  
 Diameter ..... 172 cm  
 In-flight pitch adjustment ..... none

### IVO Prop

Airscrew with in-flight adjustable pitch made of CRP / GRP

Model ..... IVO Prop medium ccw 3B  
 Number of blades ..... 3  
 Diameter ..... 172 cm  
 In-flight pitch adjustment ..... electric, continuous adjustable



## 1.12 Unit Conversion

<b>Multiply</b>	<b>by</b>	<b>to obtain</b>
kts (knots)	1.852	km/h
km/h (kilometres per hour)	0.54	kts
mph (miles per hour)	1.61	km/h
km/h (kilometres per hour)	0.62	mph
ft (feet)	0.305	m
m (metres)	3.28	ft

### 1.13 Abbreviations and Terminology

<b>ACL</b>	Anti-Collision Light
<b>AGL</b>	Above Ground Level
<b>ATC</b>	Air Traffic Control
<b>BCAR</b>	British Civil Airworthiness Requirements
<b>BUT</b>	Bauvorschriften für Ultraleichte Tragschrauber – German design specification for microlight gyroplanes
<b>CAS</b>	Calibrated AirSpeed – indicated speed corrected for installation errors
<b>ccw</b>	Counter Clock Wise
<b>CG</b>	Centre of Gravity
<b>CHT</b>	Cylinder Head Temperature
<b>CRP</b>	Carbon Reinforced Plastic
<b>CSP</b>	Constant Speed Propeller
<b>DA</b>	Density Altitude
<b>DOM</b>	Date of Manufacture
<b>DULV</b>	Deutscher UltraLeichtflugVerband e.V.
<b>Empty Wt</b>	Empty Weight of the gyroplane including oil, cooling liquid and unusable fuel
<b>G / g</b>	G-loading as a factor of gravity
<b>GEN</b>	Generator
<b>GPS</b>	Global Positioning System
<b>GRP</b>	Glass Reinforced Plastic
<b>HP</b>	horsepower
<b>hrs</b>	hours
<b>H/V</b>	Height-Velocity
<b>IAS</b>	Indicated AirSpeed – airspeed values in this manual refer to indicated air speed
<b>ICAO</b>	International Civil Aviation Organization
<b>In Hg</b>	(Manifold) Pressure, corresponding to inch mercury
<b>ISA</b>	International Standard Atmosphere
<b>JNP</b>	JahresNachPrüfung – Annual Inspection
<b>kW</b>	kilowatt
<b>LED</b>	Light Emitting Diode
<b>LH</b>	Left-Hand
<b>LOEP</b>	List Of Effective Pages
<b>ltr</b>	Litre
<b>MAP</b>	Manifold Absolute Pressure
<b>MCP</b>	Maximum Continuous Power
<b>MTOM</b>	Maximum Take-Off Mass
<b>OAT</b>	Outside Air Temperature
<b>PA</b>	Pressure Altitude
<b>POH</b>	Pilot Operating Handbook

<b>RBT</b>	Rotor Bearing Temperature
<b>RH</b>	Right-Hand
<b>RON</b>	Research Octane Number
<b>RPM</b>	Revolutions Per Minute
<b>sqm</b>	Square metres
<b>TAS</b>	True AirSpeed – calibrated airspeed corrected for air density
<b>TCU</b>	Turbo Control Unit (engine)
<b>TOC</b>	Table Of Contents
<b>TOP</b>	Take-Off Power
<b>V<sub>A</sub></b>	Design maneuvering speed
<b>V<sub>B</sub></b>	Design speed for maximum gust intensity
<b>VFR</b>	Visual Flight Rules
<b>V<sub>H</sub></b>	Maximum level-flight speed at maximum continuous power
<b>V<sub>Hmin</sub></b>	Minimum level-flight speed
<b>V<sub>NE</sub></b>	Never-Exceed Speed – maximum speed that must never be exceeded
<b>VOX</b>	Voice Operated eXchange, means: voice activation (level)
<b>VPP</b>	Variable Pitch Propeller
<b>VSI</b>	Vertical Speed Indicator
<b>V<sub>x</sub></b>	Speed for best angle of climb
<b>V<sub>y</sub></b>	Speed for best rate of climb and maximum endurance
<b>W&amp;B</b>	Weight and Balance
<b>yrs</b>	years

## CONTENTS

2.1	General .....	2-1
2.2	Environmental Limitations.....	2-2
2.3	Colour Code for Instrument Markings .....	2-3
2.4	Airspeed Limitations and Instrument Markings.....	2-4
2.5	Rotor Speed Limitations and Instrument Markings.....	2-4
2.6	Power Plant Limitations and Instrument Markings.....	2-5
2.7	Weight and Balance .....	2-7
2.7.1	Weight Limits .....	2-7
2.7.2	Centre of Gravity (CG) Limits.....	2-7
2.7.3	Demonstrated Structural Load Factors.....	2-7
2.8	Flight Crew .....	2-8
2.9	Kinds of Operation.....	2-8
2.10	Fuel.....	2-9
2.10.1	Approved Fuel Grades.....	2-9
2.10.2	Operation with leaded AVGAS fuels.....	2-10
2.10.3	Fuel Tank Capacities .....	2-10
2.10.4	Unusable Fuel.....	2-10
2.11	Minimum Equipment.....	2-10
2.12	Placards .....	2-11

INTENTIONALLY LEFT BLANK

## SECTION 2 - LIMITATIONS

This section contains operating limitations, instrument markings and basic placards which are required for safe operation of the gyroplane, including its engine, and standard equipment or systems.

### 2.1 General

#### WARNING

The operation of a gyroplane demands professional pilot instruction and dedicated training on gyroplanes. The aircraft must only be flown by a properly qualified and licensed pilot.

#### WARNING

Positive G load on the rotor must be maintained during all flight manoeuvres. Do not perform any manoeuvres resulting in the sensation of feeling light or near weightless.

#### WARNING

Smoking on board is prohibited!

#### CAUTION

This gyroplane has been designed and tested for a safe design load of 3.5g at maximum take-off weight 500kg / 3.0g at maximum take-off weight 560kg. Note that flying at high speeds in turbulent air, especially in combination with aggressive manoeuvres or a steep turn, can easily create high loads on the aircraft.

#### NOTE

This gyroplane does not comply with the terms of the international authority for civil aviation (ICAO). Therefore, it is not permitted to operate it in international airspace unless specific intergovernmental agreements allow the flight. The reason for this is that there is no international common basis for gyroplanes type approval.

**NOTE**

During the approval/certification process all required safe loads have been successfully demonstrated. However, the gyroplane may be exposed to unpredictable and high loads especially when operated on rough surfaces, such as an unprepared grass strip. In this case it is even more essential to perform a thorough pre-flight inspection and have components and parts replaced, where needed.

**NOTE**

The choice, selection and use of this particular aircraft for the purpose chosen is at the sole discretion and responsibility of the owner/pilot. RotorSport UK Ltd and AutoGyro GmbH take no responsibility for your decision to fly.

This aircraft is operated under a Permit to Fly, or restricted Certificate of Airworthiness. This means that it is only allowed to be used for recreation, or flight training (where allowed). It also means that the aircraft has not been certified to any international standard, and that the components used in the aircraft are not necessarily certified parts. Whilst the manufacturer takes great care to ensure the parts are of appropriate quality, the level of guaranteed service is less than that with a certified aircraft, and pilot operators must consider this in their flight planning

In common with other aircraft of this type the Calidus utilises a non-certified engine. This means that there may be a higher risk of engine failure than in a certified aircraft, with the associated risks of damage or injury as the result of an unplanned landing. Therefore strict compliance with the engine manufacturer's maintenance schedules, operational procedures and any additional instructions which may be given to you by AutoGyro GmbH, on behalf of the engine supplier, is essential. The aircraft must always be flown with the risk of engine failure in mind, and must not be flown over any areas where a forced landing cannot be safely executed.

Similarly the aircraft instruments (and other equipment) are non-certified. Gauges may fail completely, or part fail such that a gauge may under or over-read, or fluctuate. Good judgement must be used in monitoring instruments, and timely action taken should a reading be in doubt.

## 2.2 Environmental Limitations

Maximum wind speed or gust intensity .....	40 kts
Maximum demonstrated crosswind component for take-off and landing 22/15 kts	
Maximum tailwind component for take-off and landing.....	5 kts
Maximum demonstrated operating altitude .....	12,000 ft
<b>Demonstrated OAT for safe operation</b> .....	- 20 to + 40 °C

**CAUTION**

When operating at high altitudes the engine performance is diminished, such that there is little available power if operating at 10,000ft with a 912ULS engine.

Care must be used operating a 914UL engine at high altitudes, as it is possible to overspeed the engine in level flight at max power. Take care to monitor the engine rpm gauge.

Aircraft and engine performance degrades with decreasing pressure altitude and increasing temperatures. Care must be taken to maintain safe flight when nearing operational temperature extremes.

**WARNING**





Do not consider flying in the likelihood of severe weather. Thunderstorms may develop rapidly with the risk of heavy precipitation or hail, severe turbulence with strong vertical air movements, and lightning strike. If, despite proper flight planning, a thunderstorm should be encountered, consider a precautionary landing to avoid the squall line. A lightning strike may damage the main rotor bearing. Thorough inspection and maintenance after lightning strike must be performed.

**2.3 Colour Code for Instrument Markings**

<b>Red</b>	Operating limits. Pointer should not enter red during normal operation
<b>Yellow</b>	Precautionary or special operating procedure range
<b>Green</b>	Normal operating range



## 2.4 Airspeed Limitations and Instrument Markings

Air Speed	Marking	
<b>V<sub>NE</sub> Never Exceed Speed</b>	Red radial	 <b>185 km/h (115/120mph)*</b>
	Yellow arc	 130 – 185 km/h (80-115/120mph*)
<b>V<sub>B</sub> design speed for max. gust intensity</b>	Green arc	 30 - 130 km/h (20-80mph)
	Yellow arc	 0 – 30 km/h (0-20mph)

\* The UK BCAR Sect T approval is to V<sub>NE</sub>=120 mph, and the German BUT is to V<sub>NE</sub>=185 km/h, Ensure the red line is marked in line with your local country approval.

### WARNING

The maximum speed V<sub>NE</sub> must never be exceeded!





### WARNING

Depending on installed optional equipment V<sub>NE</sub> may be lower! Supplemental information in SECTION 9 must be respected!





### WARNING

Sudden or large control input to the front must be avoided at all means, even at airspeeds within green arc. Do not exceed V<sub>B</sub> when flying through turbulence, gusts or rough winds!

## 2.5 Rotor Speed Limitations and Instrument Markings

Rotor Speed	Marking	
<b>Rotor speed limit</b>	Red radial	 <b>610 RPM</b>
Rotor speed caution range	Yellow arc	 550 – 610 RPM
Normal range	Green arc	 200 – 550 RPM
<b>Maximum pre-rotation speed</b>	Yellow radial	 <b>220 RPM (Rotorhead II)</b>
		 <b>320RPM (Rotorhead III)</b>

## 2.6 Power Plant Limitations and Instrument Markings



Engine Speed	Marking	
<b>Maximum engine speed</b>	Red radial 	<b>5800 RPM</b>
5 minute take-off power regime	Yellow arc 	5500 – 5800 RPM
<b>Maximum continuous power</b>	Green arc 	<b>1400 – 5500 RPM</b>
<b>Recommended pre-rotation clutch speed</b>	Green radial 	<b>2000 RPM*</b>
	Yellow arc 	0 – 1400 RPM

\* Use 1600 RPM recommended pre-rotation clutch speed on aircraft with red OVERDRIVE push button

Engine Oil Temperature	Marking	
<b>Maximum oil temperature</b>	Red radial 	<b>130 °C</b>
	Yellow arc 	110 – 130 °C
<b>Normal range</b>	Green arc 	90 – 110 / 130 °C**
	Yellow arc 	50 – 90 °C
<b>Minimum oil temperature</b>	Red radial 	<b>50 °C</b>

### NOTE

When evaluating oil temperature, take note of the position of the temperature sensor. In early aircraft it is situated in the oil pump, in the return line from the oil cooler – and therefore tends to indicate a low temperature reading. In later aircraft the oil temperature is measured in the oil tank, and is the temperature of the oil as it exits the engine - and indicates hotter. In this instance the oil is then cooled in the oil cooler, and returned to the engine.

Cylinder Head Temperature***	Marking	
<b>Maximum cylinder head temperature</b>	Red radial 	<b>135 °C</b>
	Green arc 	50 – 135 °C

Alternatively (depending on engine configuration)

Coolant Temperature (CT) <sup>***</sup>	Marking	
Maximum coolant temperature	Red radial	120 °C
	Green arc	50 – 120 °C

<sup>\*\*\*</sup>Whether CHT or CT is indicated depends on cylinder head design

Engine Oil Pressure	Marking	
Maximum oil pressure	Red radial	7 bar
	Yellow arc	5 – 7 bar
Normal range	Green arc	2 – 5 bar
	Yellow arc	0.8 – 2 bar
Minimum oil pressure	Red radial	0.8 bar

<sup>\*\*</sup> Depending on configuration/Date of Manufacture: Up to DOM 10.2013 90 – 110 °C, from DOM 10.2013 90 – 130 °C

Manifold Pressure* ROTAX 912 ULS	Marking	
Maximum manifold pressure	Red radial	31 In Hg
	Yellow arc	27 – 31 In Hg
Maximum continuous MAP	Green arc	0 - 27 In Hg

Manifold Pressure* ROTAX 914 UL	Marking	
Maximum manifold pressure	Red radial	39 In Hg
	Yellow arc	31 – 39 In Hg
Maximum continuous MAP	Green arc	0 - 31 In Hg

\* Applicable only if installed, MAP gauge is optional equipment although recommended (and required in some markets) in conjunction with an adjustable pitch propeller. MAP limits do not apply at 912ULS engine speeds above 5100 RPM, marked by a yellow triangle at the RPM gauge / engine speed indicator.

## 2.7 Weight and Balance

### 2.7.1 Weight Limits

Maximum take-off mass (MTOM): ..... 450 kg / 500 kg /560 kg

\*see Type Approval or Type Certificate Data Sheet

#### CAUTION

**The take-off weight is the total weight of the gyroplane including empty weight, optional/additional equipment, occupants, fuel, and luggage at take-off. The maximum value specified above must never be exceeded.**

Maximum weight in front seat (incl. compartment below seat): ..... 125 kg

Minimum weight in front seat (incl. compartment below seat): ..... 65 kg

Maximum weight in aft seat (incl. compartment below seat): ..... 125 kg

#### NOTE

**Pilots in the front seat weighing less than 65 kg must carry corresponding ballast.**

#### Storage compartments below front and aft seat

Maximum weight in each storage compartment (4 ea.) ..... 2.5 kg (UK 2.0Kg)

#### NOTE

**When loaded, the weight in each storage compartment has to be deducted from the maximum weight in the respective seat.**

### 2.7.2 Centre of Gravity (CG) Limits

The centre of gravity is considered to be within limits if all weight limits above are respected. For details see SECTION 6 of this manual.

### 2.7.3 Demonstrated Structural Load Factors

Demonstrated positive load factor (500 kg) ..... + 3.5 g

Demonstrated negative load factor (500 kg) – structural limit ..... - 1 g

Demonstrated positive load factor (560 kg) ..... + 3.0 g

Demonstrated negative load factor (560 kg) – structural limit ..... - 1 g

**Important note:** the indication of a demonstrated negative load factor represents a structural limit only. In flight, the limitations (see 2.9) have to be respected at all times.

## 2.8 Flight Crew

Minimum crew is one pilot in the front seat.

Harness in aft seat must be fastened and tight.

The aft control stick should be removed unless the passenger seat is occupied by a qualified flight instructor.

## 2.9 Kinds of Operation

Only day VFR operation is approved!

Aerobatic flight is prohibited!

### NOTE

**Manoeuvres involving bank angles of more than 60° are considered to be aerobatic flight.**

Low-G manoeuvres are prohibited!

### WARNING

**Any maneuver resulting in a low-G (near weightless) condition can result in a catastrophic loss of lateral/roll control in conjunction with rapid main rotor RPM decrease. Always maintain adequate load on the rotor and avoid aggressive forward control input performed from level flight or following a pull-up.**

Excessive side-slip is prohibited!

### WARNING

**Side slip may be performed only with proper training and within safe boundaries. Use gentle pedal input for initiation and stabilization. Do not rely on airspeed indication in side slip. Never perform abrupt control stick input into the direction of motion. Be aware that excessive side slip particularly in strong/gusty conditions may result in an uncontrollable and unrecoverable attitude.**

Flight in icing conditions is prohibited!

**NOTE**

**Icing may occur even at temperatures above freezing!**

Operation in strong gusts or wind speeds of more than 72 km/h (45mph, 40 kts) is prohibited!

## 2.10 Fuel

### 2.10.1 Approved Fuel Grades

**Preferred fuel**

EN 228 Super or EN228 Super plus (min. ROZ 95) / MOGAS  
AVGAS UL91 (ASTM D7547)

**Alternate fuel**

AVGAS 100 LL (ASTM D910)  
E10 (unleaded gasoline blended with 10% ethanol)

**NOTE**

**When refuelling, attach the earth line to the exhaust pipe to prevent static electrical discharges!**

**NOTE**

**If none of the mentioned fuels is available, consult the corresponding European Standard EN228 as a reference. The fuel needs to be assessed at least in the octane number and the maximum ethanol content equal or better.**

**NOTE**

**AVGAS 100 LL places greater stress on the valves seats due to its high lead content and forms increased deposits in the combustion chamber and lead sediments in the oil system.**

**NOTE**

**AutoGyro recommends E10 not for permanent and sustained use. Don't let E10 remain in the fuel system for an unnecessarily long time or for long-term storage!**

For operational constraints and maintenance aspects when using preferred fuel and alternate fuel, refer to the engine manufacturer's manual.

### 2.10.2 Operation with leaded AVGAS fuels

If the engine is operated more than 30 % of engine operating time with leaded AVGAS fuels, the following maintenance operations are necessary in addition by latest after every 50 operating hours:

- change of oil filter,
- change of engine oil,
- oil level check, etc.,

according to the most recent engine manufacturer's maintenance manual

#### NOTE

**When operating primarily on leaded AVGAS fuel, it is recommended to make a change of engine oil every 25 operating hours.**

### 2.10.3 Fuel Tank Capacities

Maximum tank capacity, standard tank.....	39 ltr
Maximum tank capacity, with optional auxiliary fuel tank.....	75 ltr

### 2.10.4 Unusable Fuel

Unusable fuel quantity, standard tank.....	0.6 ltr
Unusable fuel quantity, with optional auxiliary fuel tank.....	1.2 ltr

## 2.11 Minimum Equipment

The following equipment must be operative for flight:

- Air speed indicator
- Altimeter
- Compass
- Side slip indicator
- Rotor RPM indicator
- Engine instruments (oil pressure, RPM, CHT)
- Pre-rotator

**Local Airspace Law may require an operational radio and/or transponder, ELT, or other equipment. It is the operator's responsibility to ensure the aircraft is compliant.**

## 2.12 Placards

In clear view of the pilot:

Only VFR day is approved  
 Aerobatic flight prohibited!  
 Low-G manoeuvres prohibited!  
 Flight in icing conditions prohibited!  
 For additional limitations see Flight Manual!

Max. gross weight: \_\_\_\_\_  
 Empty weight: \_\_\_\_\_  
 Max. useful load: \_\_\_\_\_

At front seat:

Max. weight in seat: 125 kg  
 Min. weight in seat: 65 kg

At aft seat:

Max. weight in seat: 125 kg

Solo from front seat only

Occupant warning (front and aft seat):

**OCCUPANT WARNING**  
 This aircraft has not been certified to an  
 international requirement



At each storage compartment below seats:

<b>Max. load:</b>	<b>2.5 kg</b>
<b>W&amp;B must be respected!</b>	

At fuel filler neck:

<b>Min. ROZ 95</b>
<b>AVGAS 100LL</b>

At fuel filler neck:

<b>Capacity Std. Tank</b>	<b>39 litres</b>
<b>With Aux. Fuel Tank</b>	<b>75 litres</b>

At oil filler neck:

<b>Engine Oil:</b> _____
<b>Approved oil types see engine manual!</b>

At throttle quadrant

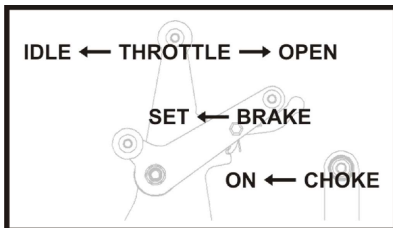

At fuel shut-off valve:

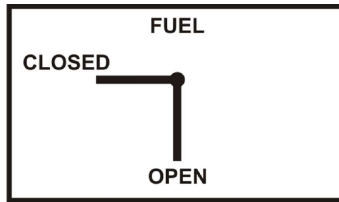

At canopy locking lever:

Inside



Outside



At both static ports:

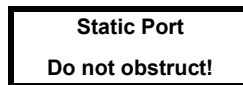

## CONTENTS

3.1	Engine Failure .....	3-1
3.2	Air Restart Procedure .....	3-2
3.3	Landing into Trees or High Vegetation .....	3-2
3.4	Degradation of Engine Power .....	3-3
3.5	Evacuating the Aircraft .....	3-3
3.6	Smoke and Fire .....	3-3
3.7	Canopy Open in Flight .....	3-4
3.8	Off-field Landing .....	3-4
3.9	Flight Control Malfunction .....	3-5
3.9.1	Engine Power Control / Throttle .....	3-5
3.9.2	Rudder Malfunction .....	3-5
3.9.3	Rotor Head Control .....	3-5
3.9.4	Trim runaway .....	3-5
3.13	Warning Lights .....	3-8
3.13.1	GEN (orange) or Low Volt (orange) Indicator Light .....	3-8
3.13.2	Low Volt .....	3-9
3.13.3	BOOST WARN Light 'Boost' (red) - only ROTAX 914 UL .....	3-9
3.13.4	BOOST CAUTION Light 'Caution' (orange) - only ROTAX 914 UL .....	3-10
3.13.7	Fan (orange) .....	3-10
3.13.8	Water Temperature Indication (Water Temp. / if installed) .....	3-10
3.14	Parameters out of Limits .....	3-11
3.15	Additional Cockpit Indications .....	3-12
3.15.1	Canopy Indication (if installed) .....	3-12
3.16	Loss of Visibility .....	3-12
3.17	Recovery System / Rotor System .....	3-12
3.18	Rotor Icing .....	3-12
3.19	Landing with a Deflated Tyre .....	3-13
3.20	Failure of Variable Pitch Propeller (if installed) See also Section 9. ....	3-13
3.21	Alternative Method of Engine Shut-down .....	3-14
3.22	Emergency exit after an aircraft roll over .....	3-14



INTENTIONALLY LEFT BLANK

## SECTION 3 - EMERGENCY PROCEDURES

This chapter contains the check lists and procedures to be executed in emergency situations.

Emergencies due to defects of the gyroplane or its engine are extremely seldom if the aircraft is checked thoroughly before each flight and continuously maintained. If there should occur a case of emergency anyhow, the guidelines of this chapter are to be followed in order to manage the emergency.

This gyroplane, like most recreational air vehicles, is fitted with a non-certified engine. This means that there may be a higher risk of engine failure than with a certified aircraft engine, with the associated risks of damage or injury as the result of an unplanned landing. Therefore strict compliance with the engine manufacturer's maintenance schedules, operational procedures and any additional instructions is essential. The aircraft must always be flown with the risk of engine failure in mind, and must not be flown over any areas where a forced landing cannot be safely executed.

### 3.1 Engine Failure

In case of an engine failure the following action is recommended:

#### **Engine failure during take-off run**

- Maintain directional control using sensitive but appropriate pedal input
- With the rotor/stick remaining aft, let gyroplane decelerate. Wheel brakes may be used to assist
- At walking speed level-off rotor disc, use wheel brakes and bring rotor to a stop

#### **Engine failure after lift-off and below 150 ft AGL**

- The climb-out should be performed according to the Height-Velocity-Diagram in CHAPTER 5
- When engine failure occurs, immediately lower nose to enter glide attitude
- Continue straight ahead – a 180 turn back to the airfield may be a bad option
- Maintain airspeed until ground is approached, then perform flare
- Depending on final approach speed be prepared to flare more distinctly than normal

#### **Engine failure at or above 150 ft AGL**

- Consider wind speed and direction
- Select a suitable landing site
- If time allows, a restart may be attempted, see "Air restart procedure" below
- Perform a landing into wind and/or upslope if possible
- Prior to touch-down switch OFF Main Switch

**WARNING**

The aircraft roll & yaw response and nose drop response to engine failure will become more prominent the faster the speed. The roll/yaw response is due to sudden removal of engine torque, meaning then that the roll trim tries to correct the aircraft attitude without a force to oppose it. Allowed to continue unchecked, the aircraft will pick up speed in the descent and roll level. The correct response is to gently pull the nose up to the airspeed and attitude required for the considered emergency landing. At light weight the nose drop will be rapid.

**WARNING**

Always plan your route to remain within safe gliding distance to areas where a safe forced landing can be performed in case of an engine failure. A landing in high trees or open waters may end fatally.

**NOTE**

The best engine-off glide ratio is about 1:3 at 90 km/h (55-60mph). Depending on a possible headwind the glide may be extended by slightly increasing airspeed. It is heavily recommended to train your forced landing capabilities regularly, preferably with a qualified flight instructor.

### 3.2 Air Restart Procedure

- Check fuel valve OPEN
- Check fuel pump(s) ON
- Check both magnetos ON
- Throttle slightly open
- With the left hand, turn the Main Switch/Starter key completely to OFF, then START
- If possible, allow engine and oil to warm-up before full power is applied

**NOTE**

The starter interlock function prevents inadvertent starter engagement. Before attempting an engine start, the interlock must be reset by turning the Main Switch/Starter key to OFF.

### 3.3 Landing into Trees or High Vegetation

- Assume the surface of the treetops or vegetation as level
- Plan touch-down and flare with minimum ground speed and minimum rate of descent

- As soon as the wheels contact the vegetation bring the rotor disc to level attitude to avoid partial blade tip contact with vegetation
- Shut down engine by switching magnetos OFF and master switch OFF

### 3.4 Degradation of Engine Power

A gradual decay in engine RPM, accompanied by a rough running engine or even vibration may be an indicator for carburettor icing. In this case, continue with a high power setting and change altitude into air which is less susceptible to carburettor icing.

If the situation cannot be corrected be prepared for further loss of power and ultimately engine failure.

#### NOTE

**The phenomenon of carburettor icing is extremely unlikely with these engine types. For the 912ULS installation the carburettor inlets draw warm air from within the engine compartment. For the 914UL installation, the air is heated by the turbocharger before entering the carburettor. Note that this arrangement can work properly only when the engine is at normal operating temperature.**

### 3.5 Evacuating the Aircraft

In normal circumstances occupants should never leave the aircraft while the propeller or the rotors are turning. If abandoning the aircraft in an emergency the pilot should turn off the engine magneto switches and turn the master switch to "OFF" if this can be done without endangering the occupants.

If abandoning the aircraft with either the propeller and/or the rotors turning the occupants should follow a path in line with the nose of the aircraft, to minimise the risk of being struck by either the rotor or the propeller.

Occupants should be briefed before flight on emergency evacuation procedures, including:

- Actions to be taken in the event of a forced landing
- Operation of the seat harness
- How to open the canopy, or to break the canopy plexiglass if required (using the emergency hammer to break the Plexiglas)
- How to safely exit and move away from the aircraft

### 3.6 Smoke and Fire

Indications of smoke should be treated in the same way as a fire.

#### NOTE

**The fire warning system (in markets where fitted) will illuminate a RED flashing warning lamp on the panel when the special cable in the engine bay has melted due to the effect of high temperatures (fire). This lamp shows solid red when a system fault is detected.**

In case of fire the following action is recommended:

### Smoke or fire on ground

- Both magnetos OFF and master switch OFF to shut-down engine and fuel pumps
- Evacuate aircraft
- Close fuel shut-off valve if situation allows
- Extinguish fire and have damage inspected

### Fire in flight

- If the warning is from the Fire warning lamp, try to establish if the fire warning is true with tight turns or similar to check for smoke and flame.
- If satisfied that the danger is present, and safe to do so, turn off the emergency fuel cut-off located in front of the passenger seat base and stop the engine (this completely isolates the engine bay from the fuel system)
- Switch off cabin heat (if engine-supplied hot air system is installed – push heat control)
- Open ventilation for fresh air
- Initiate an emergency landing
- Initiate emergency call, if time and situation permits
- As soon as a power-off landing can be assured, shut down engine by switching magnetos OFF and master switch OFF, and fuel selector OFF if not already closed.
- Continue procedure as described in “Engine Failure” and “Smoke or fire on ground”

#### NOTE

**The engine bay firewall is fireproof to 15mins minimum duration, so a descent from 12,000ft operational ceiling at 1000fpm will enable a landing within the fireproof limits.**

## 3.7 Canopy Open in Flight

If the canopy is found not unsecured in flight, immediately initiate a left side-slip (i.e. right pedal) so that the oncoming air keeps the canopy shut. Reduce air speed and lock the canopy. If impossible to secure with the locking handle, land immediately at the nearest suitable location. Approach with the nose pointed to the right (left side slip) and align just prior to touch-down.

## 3.8 Off-field Landing

A precautionary landing at a non-prepared site may be performed at pilot's discretion in order to avoid unexpected weather, in case of severe illness of the pilot or a passenger, or if technical defects are suspected, for example sudden and severe rotor vibrations.

- Select a suitable landing site from safe altitude, considering slope, wind speed and direction
- Fly a reconnaissance pattern to check for obstacles, especially power lines, wires, and cables in the approach and go-around path
- Overfly the landing site to check for obstructions such as fences, ditches, rocks, height of vegetation, and select most suitable touch-down zone
- Perform a normal approach and touch-down into wind with minimal ground speed



### 3.9 Flight Control Malfunction

In case of a flight control failure the gyroplane can be controlled with the remaining primary and secondary controls, including power and trim. An immediate reduction of power, respectively speed may be necessary to avoid pitch oscillations (phugoid) or other effects affecting dynamic or static stability. Navigate to a suitable landing site with wide and shallow turns and approach against the wind.

#### 3.9.1 Engine Power Control / Throttle

##### Throttle jammed open or max

Navigate to a suitable landing site with the power set. If over safe terrain, magneto switches may be used to control power. When within gliding distance to the selected landing site, shut-down engine to perform a power-off landing as per Emergency Procedure "Engine failure".

#### NOTE

**In case of a control cable breakage the carburettor will be automatically set to full throttle position.**

##### Throttle jammed closed

Land as per Emergency Procedure "Engine failure". Residual power may be used to extend the glide.

#### 3.9.2 Rudder Malfunction

In case of a stuck or loose rudder, continue flight to a suitable, preferably wide landing site that allows a landing into the wind. If necessary reduce power to avoid excessive side slip. Align gyroplane prior to touch-down, using engine torque or lateral control input to the side where the nose is pointed.

#### 3.9.3 Rotor Head Control

In case of a rotor head control malfunction, control pitch attitude using careful trim input and power setting. Use rudder for directional control and for shallow turns. In some conditions it may be appropriate to reduce power/speed in order to avoid phugoid effects or a possible negative yaw-roll coupling. Approach landing site with wide and shallow turns.

#### 3.9.4 Trim runaway

Failure of a trim selector switch or pneumatic valve may result in trim runaway (where the trim system runs to one extreme and pushes the control stick accordingly). Although the average pilot is able to resist the out-of-trim stick force and continue to fly the aircraft it may be possible to reduce the stick load by intervention:

- (i) High forward stick load required to prevent aircraft nose rising (this will be coincident with a high air-pressure reading) – briefly turn the Flight/Brake selector to "Brake" to deplete system air pressure. If the air compressor is heard to start

and the pressure rises again then pull the circuit-breaker marked “Comp” to stop the compressor. Repeat the brief selection of “Brake” to deplete system air pressure as required.

- (ii) High aft stick load required to prevent aircraft diving (this will be coincident with low or zero air pressure) – check “Comp” fuse, if blown replace and try to trim aircraft nose-up. If unsuccessful or no replacement fuse available then continue to an expedited landing. Note: replace the fuse once only.
- (iii) High roll-left or roll-right stick load required to maintain balanced flight (coincident with high air-pressure reading). Pull the “Comp” fuse to prevent further increase in air pressure and attempt to re-trim. If unsuccessful then continue to an expedited landing. Selecting “Brake” will reduce forward pitch trim pressure to zero, then requiring a significant rearwards force to hold the aircraft level. Depending on the aircraft loading, this may be an appropriate response.

#### NOTE

**Stick trim malfunction can be perceived if the Flight/Brake selector has been left switched to ‘Brake’ during take-off, resulting in a pitch forward stick force; if this occurs, change the Flight/Brake switch to Flight, and trim as normal.**

### 3.10 Pitch oscillation recovery

There are generally two types of pitch oscillation: that caused by pilot over control (‘PIO, Pilot Induced Oscillation’) and that caused by aerodynamic oscillation.

PIO is not generally found on two seat gyroplanes due their inherent stability. It is initiated by the pilot over-controlling the stick. If a situation develops where a divergent aircraft pitching oscillation is occurring in sympathy with fore-aft control stick inputs, firstly stop the control input – do NOT try to control PIO with the stick.

For both situations, smoothly closing the throttle whilst maintaining a level flight attitude will return the aircraft to a stable, slow speed condition very quickly, from which the pilot can recover to normal flight.

Recovery from PIO or aerodynamic oscillation can result in height loss.

### 3.11 Vibration

A gyroplane is subject to a number of out of balance forces which will generate different levels of vibration depending on the engine and rotor rpms, and on loading conditions. Rotors are normally balanced two seated, so a reduction in occupant loading will naturally change the rotor response.

1. Engine and propeller. Vibration in this area will change with engine rpm, and can therefore be affected and isolated by the pilot. The propeller is normally balanced to less than 0.1ips, meaning low vibration. Vibration will increase as the propeller gets dirty, and will also increase if damaged. A sudden change in flight will indicate a fault has developed, either through an impact (loose luggage, bird strike etc. passing through the propeller) or by

some mechanical failure. In the event the pilot should make a precautionary landing for evaluation. Propeller damage may also be evident from a change in noise level.

Upon landing, carefully check the propeller for damage, loose bolts or evidence of mechanical failure within the prop or engine. Especially check the engine to engine bearer connections, and the engine bearer to airframe connections.

## 2. Rotor.

Rotors will vibrate in flight due to tracking errors (side to side stick shake), rotor CG misalignment with the axis of the bearing in the flat plane (oscillatory stick shake), and also in the vertical plane (two per rev shake). The amount of shake will not suddenly change in flight or between flights unless there has been mechanical failure, external influence or rotor strike.

Rotor vibration also depends on the rotor rotational speed, which in turn is dependent on airspeed and aircraft loading.

Vibration will increase (and performance decrease dramatically) with dirt build up on the rotor blades, so before any analysis make sure they are clean.

If there is a change in vibration in flight make a precautionary landing and investigate. If on rotor start up, stop and investigate.

Check items:

Rotor impact with tail of aircraft.

Hanger damage e.g. twist or distortion of trailing edge.

Blade bent from ground handling.

If after a recent re-assembly of the rotor, that the blades and hubs are serial-number matched, and that the shim washers are correctly matched to the hub bar and rotor tower.

A reduction in vibration may be caused by increased flexibility between the rotor head and the occupant. This may be control system looseness, so check all system joints for tightness, and also for cracks at the base of the mast. Check security of all fastenings between the rotor and the pilot

## 3.12 Other equipment failure

Good judgement must be used in monitoring instruments, and timely action taken should a reading be in doubt. If in doubt, make a precautionary landing and resolve the issue rather than continuing a flight.

Actions recommended:

ASI failure: In level flight fly with an engine rpm of 4,200 lightly laden to 5,000 heavily laden which will give approx 60 to 80mph. When descending (nose down) throttle back to approx 3,000 to 3,500rpm to prevent overspeed. Continue to your designated landing site, maintaining speed for a flare on landing in the final descent. Leave plenty of space to land in should the flare be prolonged. Experience will aid judgement of the best engine rpm to maintain to match the desired flight speed and payload.

Altimeter failure: In a gyroplane it is reasonably easy to judge height. If in controlled airspace ensure the controlling authority is informed to prevent traffic conflict. Otherwise continue to a safe landing using navigational skills to avoid potential collisions.

Compass failure: Resort to map, aided by GPS if available, fly at a speed to suit navigational requirements or make a precautionary landing if unable to identify position.

Rotor RPM gauge failure: This is not essential for safe flight, and rotor rpm cannot normally be affected in flight unless significant "g" or negative "g" is exerted – and then will only provide an indication of the rpm. If failed in flight, repair on landing

Engine RPM: The engine is rpm self-limiting by propeller pitch in flight. If the gauge fails, replace on landing. Use audio cues to establish rpm

Oil pressure, oil temp and water temp. A failure of one gauge can indicate an engine fault or simply a gauge fault. Watching the other gauges will indicate the likely failure mode.

For example,

1. Gauge suddenly goes to full scale deflection, other gauges reading normally – likely gauge fault
2. Oil pressure falls to zero, possible loss of pressure. Stop engine, make precautionary landing
3. Water temp gradually or suddenly rises above max temp. Possible loss of coolant. Stop engine, make precautionary landing
4. Oil temp suddenly falls to zero, other gauges reading normal – probable gauge failure.
5. Oil temp rises above maximum, other gauges normal – possible very low oil level, blocked radiator or thermostat. Stop engine, make precautionary landing.
6. Fuel level gauge suddenly falls to zero or FSD. Probable gauge failure, but always cross check to predicted fuel burn. Low fuel light will light as a backup.

Sudden large deflections are normally unlikely, with the exception of loss of pressure readings.

### 3.13 Warning Lights

#### 3.13.1 GEN (orange) or Low Volt (orange) Indicator Light

**The GEN lamp, when lit, indicates that there is no voltage being supplied from the regulator circuit to the battery. The Gen2 lamp (if fitted), when lit, indicates that there is no voltage being supplied from the external generator to the battery.**

Both are normally lit when the engine is stationary or at very low rpm.

These lamps are normally not lit in flight, but may be seen to pulse gently in low light conditions.

If the GEN and GEN2 lamps and the LOW VOLT lamp are on with the engine running at more than 2,500rpm, then it is likely that the charging circuits have failed, and that the aircraft is operating on battery power alone.

If only the LOW VOLT lamp is lit, then the aircraft voltage demand has exceeded supply, and demand must be reduced in order for the lamp to extinguish. NOTE! When lit, this lamp also indicates that the strobes, nav lights, anti-collision lights and 12v socket have been turned off automatically, with automatic reconnection when the supply exceeds demand.

If only the LOW VOLT lamp is lit, then the aircraft voltage demand has exceeded supply, and demand must be reduced in order for the lamp to extinguish. NOTE! When lit, this lamp also indicates that non-essential services and 12v socket (where fitted) have been turned off automatically, with automatic reconnection when the supply exceeds demand.

#### Required Action

**ROTAX 912 ULS:** If any of the indicators are permanently lit, switch off all unnecessary electrical consumers and land at the nearest airfield where maintenance can be performed. The battery is expected, if in good condition, to provide 30 minutes\* of reserve power to supply the aircraft instrumentation and avionics, after which time electrical equipment may cease to function.

**ROTAX 914 UL:** If any of the indicators are permanently lit, switch off all unnecessary electrical consumers, it is recommended to perform a precautionary landing within 30 minutes. The battery is expected, if in good condition, to provide 30 minutes\* of reserve power to supply the aircraft fuel pump, instrumentation and avionics, after which time electrical equipment may cease to function and fuel supply to the engine lost. Where the relay system is installed (see aircraft records), in the event of battery failure the P1 fuel pump is supplied with electrical power directly from the engine's internal generator so the engine may continue to run. However, be prepared for an engine failure.

\*depends on capacity of batteries

### Further information (914UL)

**No power in the cabin indicates either the main circuit fuse has failed, or that the battery has failed and the pump protection relay (since 09.2013 or retrofitted (UK SB-073/MC-264)) has opened. In this case the P1 primary fuel pump remains powered by the regulator directly, maintaining fuel supply to the engine. The turbo control unit is not powered in this instance, and will remain in whatever position it was in when power was lost – so mixture and manifold pressure control will be lost. Take care to only use the minimum power required to land safely to prevent engine damage.**

**In this case the primary fuel pump will continue to run until the engine alternator stops providing electrical energy. If required, fuel supply can be shut off via the fuel shut-off valve.**

#### NOTE

**A gently pulsing GEN indicator light (visible in low light conditions and depending on date of manufacture) is normal and indicates proper function of the generator.**

### 3.13.2 Low Volt

Battery voltage of the system has dropped below a safe value. Refer to chapter above. Non-essential services and the 12V power receptacle will be disabled automatically.

### 3.13.3 BOOST WARN Light 'Boost' (red) - only ROTAX 914 UL

#### Continuously lit

If continuously lit, the maximum admissible boost pressure was exceeded. Reduce power into normal operating range and consider restricted engine performance or boost control malfunction. Record duration and have maintenance action performed.

#### Blinking

When blinking, the allowable 5 minutes take-off power time limit has been exceeded. Reduce power into continuous range. Record duration and have maintenance action performed.

### 3.13.4 BOOST CAUTION Light 'Caution' (orange) - only ROTAX 914 UL

A blinking BOOST CAUTION light indicates a problem with the turbo/boost control, its sensors or the servo. Engine power is degraded and continuous operation may lead to engine damage. Perform a precautionary landing considering reduced engine performance and be prepared for engine failure.

### 3.13.5 Fire (red / if installed)

Refer to emergency procedure "Smoke and Fire" and Flight Manual Supplement.

The Fire Warning system works by constantly checking the resistance of a special cable mounted in both the engine bay and in the battery and fuel pump bay. This cable contains two wires where the insulation between the two wires melts beyond 180degC, creating a short circuit. The cable has a resistor at the end of the cable to give a known standard resistance of the detection loop.

This lamp will flash three times when the keyswitch is turned on. This indicates the system has made a satisfactory self-test. The lamp will then normally remain off.

The lamp will light a solid red when a fault has been detected (eg a short circuit to ground or open circuit). A repair is required.

The light will flash brightly if a closed circuit is detected. This indicates that the cable temperature has exceeded 180degC, and therefore that a fire may be present. Action as '3.6, Smoke and Fire'

### 3.13.6 Low Fuel (red / if installed)

The LOW FUEL warning light is triggered as soon as 5 litres or less of useable fuel remain in the tank. Perform a power-on landing at the nearest suitable location and be prepared for engine failure after approximately 10 minutes remaining flight time.



### 3.13.7 Fan (orange)

This indicates that the thermo switch of the engine mounted electrical fan has closed, and that the fan is activated. Monitor engine instruments and note the higher electrical power consumption. If possible, reduce engine power and increase speed.

Note that this advisory warning lamp is deleted in later models.

### 3.13.8 Water Temperature Indication (Water Temp. / if installed)

The water temperature indication illustrates three colour-coded temperature ranges of the engine cooling water:

INDICATION	TEMP.RANGE	CORRECTIVE ACTION
 Red light	Above 120 °C	Further reduce power. If condition cannot be corrected, land as soon as practicable.
 Yellow light	105 – 120 °C	Reduce power and increase air speed.
 Green light	Below 105 °C	Normal operation

**Note.** Following market feedback this lamp has been changed to illuminate RED at 120 °C only. The yellow and green colours are not shown in 2018 models.

### 3.13.9 Oil Pressure Indication (red / if installed)

Lighting up of the Oil Pressure Indication signals a problem within the lubrication system, which is characterised by a drop of oil pressure to or below 0.8 bar. If Oil Pressure Indication is lit cross-check with Oil Pressure Instrument, monitor Oil Pressure Instrument and consider landing. Be prepared for engine failure.

### 3.13.10 Clutch (orange) (only with Rotorhead III)

#### Continuous light

Indicates a slipping clutch during pre-rotation.

Reduce engine RPM to closer match the rotor speed, and be more gentle when increasing power.

#### Blinking

Intended take-off run with low rotor RPM – danger of blade flapping

Reduce power immediately, and stop if take-off has started. Re-apply the pre-rotator and increase rotor RPM first. If the correct take-off rotor RPM cannot be reached, abort take-off.

## 3.14 Parameters out of Limits

PARAMETER	EXCURSION	CORRECTIVE ACTION
Engine Oil Temperature	Upper <b>limit</b> or <b>yellow arc</b>	Reduce power and increase air speed. If condition cannot be corrected, land as soon as practicable.
	Lower <b>limit</b>	Allow engine to warm-up on ground.
	Within lower <b>yellow arc</b>	Uncritical as long as oil temperature has reached normal operating range at or after take-off.
Cyl. Head Temperature	Upper <b>limit</b>	Reduce power and increase air speed. If condition cannot be corrected, land as soon as practicable.
Engine Oil Pressure	Upper <b>limit</b> or <b>yellow arc</b>	Reduce power. If condition cannot be corrected, have maintenance action performed prior to next flight.
	Lower <b>limit</b>	If combined with other indications, such as rising oil temperature or unusual engine behaviour, shut-down engine and perform a power-off landing as per Emergency Procedure "Engine failure". Otherwise, monitor engine instruments carefully and land as soon as practicable. Have maintenance action performed.

### 3.15 Additional Cockpit Indications

#### 3.15.1 Canopy Indication (if installed)

Refer to emergency procedure “Canopy Open in Flight” and Flight Manual Supplement.

#### 3.15.2 Outside Air Temperature and Rotor Bearing Temperature

The Rotor Bearing Temperature (RBT) indicator is provided for condition monitoring of the rotor bearing. If, in stabilized conditions, RBT rises suddenly above OAT, have bearing inspected.

Note; from the introduction of rotorhead III in 2018 the rotor bearing temp display is deleted, because market feedback determined that this indication provided no useful information. It is replaced by OAT, with the sensor mounted below the body.

### 3.16 Loss of Visibility

In case of canopy misting, open air vents and windows to ensure proper ventilation. If the situation cannot be corrected or occurs suddenly, such as after a bird strike or canopy icing, maintain safe attitude by visual reference to the sides, using the open sliding window, if necessary.

When at safe height, stabilize the aircraft at 90 km/h (55mph) and clear the viewing obstruction by using a hand through the sliding window.

If forward vision is still impaired or lost, continue flight with a left side slip, using the open sliding window for visual reference. Land at the nearest suitable location and align just prior to touch-down.

### 3.17 Recovery System / Rotor System

This gyroplane is not equipped with a ballistic recovery system. However, its rotor system which is in permanent autorotation serves as such a system. Therefore, the entire rotor system including its rotor head with blade attachments and the corresponding components of the flight controls have to be inspected and maintained carefully.

If any undue vibration or unusual behaviour is experienced a precautionary landing should be considered.

### 3.18 Rotor Icing

Flight in icing conditions may lead to ice forming on the inner leading edge of the blade (see photo), leading to vibration and loss of lift performance. This may also be indicated by a more than normal or constantly increasing power demand. This could ultimately result in a condition where altitude cannot be maintained, even at maximum power. An iced-up rotor system can also cause severe vibration. If any of the signs for rotor icing is evident, carry out a precautionary landing.

Flight in icing conditions is NOT allowed!





Photo of rotor blade with significant icing built up

### 3.19 Landing with a Deflated Tyre

Plan to land directly into the wind with minimum rate of descent at touch-down, if possible on a grass runway. Maintain directional control with adequate pedal input. Consider the use of some propeller thrust to increase rudder effectivity. Lower nose gently with the nose wheel pointing straight.

Alternatively, if landing on asphalt is unavoidable, approach normally, with the intent of a zero-speed touch-down directly into wind.

Only if impossible to recover the aircraft from the landing area should it be manoeuvred under its own power, as this could further damage the tire and wheel rim.

### 3.20 Failure of Variable Pitch Propeller (if installed) See also Section 9.

#### Noticeable defect:

In case of a noticeable mechanical defect, indicated by sudden vibration or noise, perform a precautionary landing.

#### Run-away:

Propeller pitch changes without command, usually resulting in unexpected or sudden change in engine RPM and engine manifold pressure.

**Run-away to FINE:** RPM will increase and propeller pitch will stop in full FINE position. Reduce power if needed, to stay within RPM limits.

**Run-away to COARSE:** RPM will decrease and MAP will rise until propeller pitch stops in full COARSE position. Reduce power if needed, to stay within MAP limits.

Removing the PROP fuse will cease the pitch change. Continue according to emergency procedure 'FREEZE'.

**Freeze:**

Propeller pitch does not react to pilot input, engine RPM does not change while propeller pitch control is activated. Proceed according to the following table:

Before take off	Do not take-off
During take-off and climb	Try to keep climbing to a safe altitude, return to the airfield and land. If the aircraft does not climb, maintain altitude and to return in a flat curve.
During cruise flight	Depending on the prop position, it should be possible to find a speed and RPM to continue the flight to the next possible landing area. Depending on the prop position your descent will look different and a go around is probably not possible.
During descent	Depending on the prop position (in case of cruise), your descent will look different and a go around will probably not be possible.
During landing	Continue approach as planned. If the prop changes to cruise and the landing looks too long, keep in mind to cut the engine.

### 3.21 Alternative Method of Engine Shut-down

If the engine continues running after the magnetos have been switched off use one of the following alternative methods:

Hold throttle lever in IDLE position firmly while overstretching the cable ends of the carburettor control cables with the other hand.

**Alternatively**

Engage full choke, wait a few seconds and open the throttle suddenly. This normally chokes the engine and causes it to stop

**Alternatively – only ROTAX 914**

Turn master switch to off to deactivate both primary and secondary electrical fuel pump. The engine will starve after approximately 30 – 60 seconds.

### 3.22 Emergency exit after an aircraft roll over

An accident (especially in the take-off phase) can result in the aircraft rolling onto its side, such that there is difficulty opening the canopy in the normal manner.

If a rapid exit is required, and help not available, then the fastest exit is through the canopy.

An impact hammer is provided. If the canopy is already cracked and damaged from the impact, use the hammer and hands (protected if practical) to break a hole in the canopy using the cracks as a start point, and exit.

If the canopy is undamaged, hold the hammer at the longest distance from the impact end, and strike hard onto the plexiglass near any weakened area or in front of the occupant.

Choose the strike point to allow the holder to give the hammer the highest striking force. Repeat until the canopy is broken sufficient to exit.

## CONTENTS

4.1	Airspeeds for Safe Operation.....	4-1
4.2	Preparation for Flight.....	4-1
4.3	Daily or Pre-flight Checks.....	4-1
4.4	Before Boarding.....	4-5
4.5	Before Starting Engine.....	4-5
4.6	Starting Engine.....	4-5
4.7	Taxi and Run-up.....	4-6
4.8	Take-off Procedure.....	4-7
4.9	Take-off Run.....	4-9
4.10	Climb.....	4-10
4.11	Cruise.....	4-10
4.12	Descent.....	4-10
4.13	Approach.....	4-10
4.14	Landing.....	4-11
4.15	Go-around.....	4-12
4.16	After Landing.....	4-12
4.17	Engine Shut-down.....	4-13
4.18	Parking.....	4-13
4.19	Special Procedure: Short Field Take-off.....	4-14
4.20	Special Procedure: Slow Speed Sink and Recovery.....	4-15
4.21	Flight under Conditions of Precipitation.....	4-16
4.22	Flight with Summer Canopy.....	4-16
4.23	Engine In-flight Shut-down and Air Restart.....	4-16
4.24	Noise Abatement.....	4-17



INTENTIONALLY LEFT BLANK

## SECTION 4 - NORMAL PROCEDURES

This section contains check list items, instructions and procedures for the operation of the gyroplane. However, these procedures do not replace the pilot's appreciation of the individual situation.

### 4.1 Airspeeds for Safe Operation

Climb .....	100 -110km/h (60-70mph) IAS
Best rate of climb / best endurance .....	90 km/h (55mph) IAS
Best range .....	130 km/h (80mph) IAS
Approach .....	100 km/h (60mph) IAS

### 4.2 Preparation for Flight

The pilot shall be familiar with the aircraft limitations detailed in SECTION 2 of this manual and shall have performed proper flight planning considering required legal aspects, as well as SECTION 5 'PERFORMANCE' and SECTION 6 'WEIGHT AND BALANCE' of this manual. The use of check lists as provided in this manual is mandatory for a safe operation.

### 4.3 Daily or Pre-flight Checks

All daily or pre-flight check list items consist of visual checks and do not replace professional mechanical inspection and maintenance. The following check list applies for the standard Calidus gyroplane.

Note that depending on optional equipment installed the necessary checks may include additional items according to the flight manual supplement provided with the optional equipment. It is advisable for the owner/operator to compile his own check list suitable to his particular configuration.

The pre-flight check is structured into 11 stations which are organized as a clock-wise walk-around to provide a logical flow and sequential order, thus minimizing the risk of left-over or overlooked items.

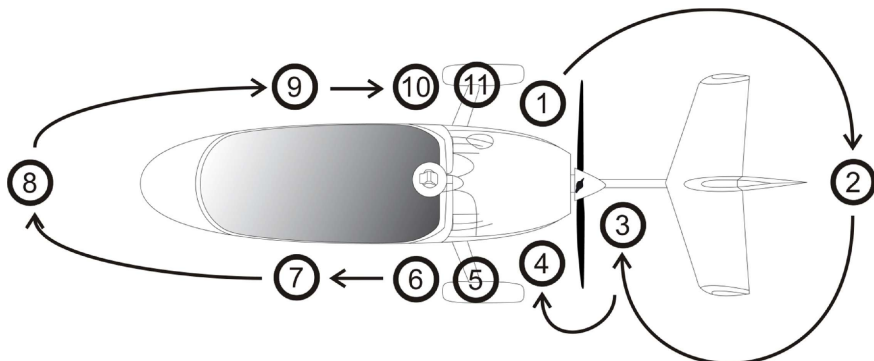

The following checks must be carried out before each flight. However, if the gyroplane is operated by a single pilot or within an organization where the checks are performed by or under the supervision of qualified personnel, check list items marked with a preceding 'O' may be carried out daily, before the first flight of the day.

**Before exterior check**

- O Fuel tank drain(s)..... Sample
- O Snow/ ice (if any)..... Removed
- Documents ..... Check complete

**Exterior check**

**Station 1** (engine, RH side)

*Open RH access door*

- O Before turning prop: MAG switches ..... Check OFF
- O Engine oil level ..... Check
- O Dip stick and oil cap..... Installed and secure
- O Coolant level..... Check

*Close RH access door*

- Oil cooler and hoses RH..... Clean, no leaks, fittings tight
- Exhaust system RH.....No cracks
- Engine cowling RH ..... Properly installed, all fasteners locked
- External generator .....Secure, V-belt in good condition

**Station 2** (stabilizer)

- O Stabilizer general condition..... Check
- Stabilizer attachment ..... Check
- Rudder control cable linkage ..... Check
- Upper rudder bearing..... Secure, no excessive play
- Rotor blades condition and cleanliness..... Check
- Blade tips ..... Tight

**Station 3** (keel tube and propeller)

- Keel tube protection pad ..... No excessive wear
- Propeller condition and cleanliness ..... Check
- Propeller leading edge and tips ..... No damage
- Spinner (if installed) ..... Tight, no cracks
- Variable pitch propeller (if installed): brushes ..... Check
- Variable pitch propeller (if installed): edge strips ..... Check

**Station 4** (engine, LH side)

- Main frame rear side / welded joints ..... No cracks, no deformation
- Oil cooler and hoses LH ..... Clean, no leaks, fittings tight
- Exhaust system LH ..... No cracks
- Engine cowling LH ..... Properly installed, all fasteners locked

**Station 5** (main gear spring spar, LH)

- LH Main wheel running surface ..... Check
- Air pressure and slip mark ..... Visual check
- Brake, disc attachment (4 bolts) and wheel attachment ..... Check
- Wheel spat and attachment ..... Check
- Main gear spring spar attachment ..... Check
- Main gear spring spar ..... No cracks
- Vibration decoupling element attachment (2x) ..... Check
- Rotor flight control ..... No excessive play and secure
- Teeter bolt (bolt end) ..... Free to turn
- Teeter bolt (nut end) ..... Split pin installed

**Station 6** (passenger station, LH side)

Aft canopy hinge ..... Secure

**Station 7** (pilot station, LH side)

Forward canopy hinge ..... Secure

Canopy sliding window and frame ..... Check, no cracks

Static port ..... Clean and open

**Station 8** (forward fuselage and canopy)

- General appearance ..... OK
- Pitot cover (if installed) ..... Removed
- Pitot tube ..... Clean and open
- Rotor lash bag (if sufficient brake pressure) ..... Removed
- Canopy condition and cleanliness ..... Check, no cracks
- Nose wheel condition and air pressure ..... Check



**Station 9** (pilot station, RH side)

- Static port ..... Clean and open
- MAG switches ..... Check OFF
- Rotor brake pressure ..... min. 6 bar
- Throttle lever ..... Check function, full travel
- Brake lever and lock ..... Check function and condition
- Brake fluid level ..... Check
- Pedals and control linkage ..... Check
- Forward control stick bolts and nuts ..... Secured
- Monocoque structure condition ..... Check
- Loose objects ..... Removed/secured

**Station 10** (passenger station, RH side)

- Aft seat belts ..... Fastened and tight
- Aft control stick ..... Removed
- If installed*: free travel, no contact with back rest ..... Checked/adjusted
- Monocoque structure condition ..... Check
- Loose objects ..... Removed/secured

**Station 11** (main gear spring spar, RH)

- RH Main wheel running surface ..... Check
- Air pressure and slip mark ..... Visual check
- Brake, disc attachment (4 bolts) and wheel attachment ..... Check
- Wheel spat and attachment ..... Check
- Main gear spring spar attachment ..... Check
- Main gear spring spar ..... No cracks
- Lower rotor flight control attachments ..... No excessive play and secure
- Cooling air intake ..... No obstructions
- Vibration decoupling element attachment (2x) ..... Check
- Gimbal head bolts (2x) ..... Split pin installed
- Rotor flight control attachments ..... No excessive play and secure
- Main rotor bearing ..... Check condition
- Pre-rotator assembly and brake ..... Check condition
- Teeter bolt (bolt end) ..... Free to turn
- Teeter bolt (nut end) ..... Split pin installed
- Teeter stops ..... Check
- Rotor hub and blade clamping area ..... Check
- Blade attachment bolts ..... All installed and fastened
- Inner blade caps ..... Tight
- Rotor lash bag ..... As required

**CAUTION**

**Teeter bolt must be free to turn by hand!**

#### 4.4 Before Boarding

Fuel level and fuel cap ..... Check  
 Pneumatic mode selector ..... Check BRAKE position  
 Rotor brake pressure ..... Check/set min. 6 bar  
 Rotor lash bag ..... Removed and stowed

*Passenger station:*

Passenger ..... Briefed and secure  
 Aft seat belts ..... Fastened and tight  
 Loose objects ..... Removed / secured  
 Storage compartments ..... Closed and locked  
 Fuel shut off valve ..... Open and guarded

*Pilot station:*

Loose objects ..... Removed / secured  
 Storage compartments ..... Closed and locked

#### 4.5 Before Starting Engine

Seat belts ..... Fastened  
 Flight controls ..... Free in all planes to stops, stick and rudder  
 Altimeter ..... Set to airfield elevation  
 Canopy ..... Closed and locked

#### 4.6 Starting Engine

Parking brake ..... Set

*Cold engine:*

Throttle ..... Idle  
 Choke ..... Fully engaged

*Warm engine:*

Throttle ..... Idle or slightly cracked  
 Choke ..... disengaged  
 Master switch ..... ON

**All engine variants:**

Note GEN indicator light ON  
 Note LOW VOLT may be illuminated

**ROTAX 914 engine:**

Note BOOST WARN light and BOOST CAUTION light ON for about  
 2 seconds and buzz of electrical fuel pump.

Second fuel pump P2 (if installed) ..... ON

**All engine variants:** Note (increased) fuel pump buzz when Pump 2 is  
 turned on.

Variable pitch propeller (if installed) ..... FINE  
 ACL / Strobe (if installed) ..... ON  
 Both MAG switches ..... ON  
 Propeller and area ..... "Clear"

Starter (with right hand, left hand on throttle/brake) ..... Engage

Hold starter until engine fires, but for a maximum of 10 seconds. Generally the engine fires immediately. In case of an unsuccessful starting attempt check all preconditions. Wait at least 20 seconds to allow cooling of battery and starter motor before repeated activation.

Oil pressure ..... min. 1.5 bar

Second fuel pump P2 (if installed) ..... OFF

Avionics/Radio/Intercom ..... ON

Choke ..... slowly disengage

**WARNING**

**Never attempt to start the engine until the area around the propeller is completely clear of any persons or objects. Do not start the engine while standing beside the aircraft as you will easily be struck by the propeller in case of a brake failure or an operating error.**

**4.7 Taxi and Run-up**

During taxi do not exceed 15 km/h (10mph) which is approximately jogging speed and steer with careful pedal input. Use wheel brake carefully, if needed, but not before throttle lever has been completely pulled to idle. Control stick should always be maintained in forward centre position. When taxiing on uneven ground, use particular caution and hold control stick so as to avoid the blades or control system hitting their mechanical stops.

**WARNING**

**Long taxi journeys with the brakes held on and high propeller thrust can lead to brake pad fade! Use intermittent brake application and keep engine rpm low.**

**WARNING**

**Taxiing with the canopy fully open will put high forces on the hinges, and is not recommended.**

Carry out engine run-up in an area with least risk to individuals and other airport ground traffic, preferably headed into the wind.

Warm-up RPM (ref Rotax operators manual) ..... 2000 – 2500 RPM

Oil temperature and other engine indications ..... within limits

*At taxi holding position:*

Magneto check (at 4000 RPM) ..... max. 300 RPM drop

with max. difference between magnetos ..... 115 RPM

Switch ignition/magnetos with right hand while left hand resides on throttle/brake.

Functional check VPP (if installed)..... execute (see 9-1.4.3)  
Throttle ..... Idle  
Warning and caution indications ..... None  
Instruments / altimeter ..... Cross check  
NAV lights..... As required  
Second fuel pump P2 (if installed)..... ON  
Canopy ..... Cross-check closed and locked  
Approach and runway ..... “Clear”, then line-up

**CAUTION**

**If the canopy is covered in rain drops or fogged up, ensure it is cleared before commencing take-off. Stop and clear the screen if required.**

**4.8 Take-off Procedure**

- Check relative wind
- Maintain control stick in forward position with right hand
- Switch pneumatic mode selector to FLIGHT and return to brake with left hand
- Hold wheel brake without having locking pawl engaged
- While holding wheel brake adjust throttle to give 2000 RPM (1600 RPM red overdr.)
- Activate and hold pre-rotator. To reduce lateral stick force during prerotation, adjust the forward stick position by pulling it slightly aft and to the right
- Let pneumatic clutch fully engage (stabilization at about 110 rotor RPM).  
If necessary release pre-rotator button momentarily and press again to maintain engine RPM within green arc, respectively prevent engine from stalling!
- Carefully increase throttle (~ 20 R-RPM/sec) to 200 R-RPM – max. 220 R-RPM
- When the minimum required rotor rpm is reached, release pre-rotator button
- Gently – but smartly - move control stick fully aft (stick travel ~ 1 sec.).  
In a strong headwind be prepared to stop movement before nose wheel rises!
- Release wheel brake with throttle unchanged
- Monitor rotor speed and progressively increase throttle to take-off power

If Rotorhead III is embodied, then higher pre-rotation speeds are possible and this procedure is amended:

- Check relative wind
- With right hand, maintain control stick in a forward position
- Switch pneumatic mode selector to FLIGHT and return to brake with left hand
- Hold wheel brake without having locking pawl engaged
- While holding wheel brake adjust throttle to give 2000 RPM
- Activate and hold pre-rotator. To reduce lateral stick force during pre-rotation, adjust the forward stick position by pulling it slightly aft and to the right

- Let pneumatic clutch fully engage (stabilization at about 100 rotor RPM). If necessary release pre-rotator button momentarily and press again to maintain engine RPM within green arc, respectively to prevent engine from stalling!
- Carefully increase throttle to increase rotor rpm to that required for the take-off. Minimum rotor rpm for take-off is 200, maximum achievable is 320. Between 280 and 320rpm it is possible that the high engine rpm and resultant propeller static thrust generated may be causing the aircraft to slide with wheels locked – depending on the runway surface and payload. If sliding starts reduce power! If the rpm is not sufficient for take-off, abort and restart as required.  
In case of a slipping clutch (CLUTCH light), reduce power and match engine rpm to rotor rpm.
- When the minimum required rotor rpm is reached, release pre-rotator button
- Gently - but smartly - move control stick fully aft (stick travel ~ 1 sec.), see 4.9  
In a strong headwind be prepared to stop movement as the nose wheel rises!
- Release wheel brake with throttle unchanged
- Monitor rotor speed and progressively increase throttle to take-off power
- In case if a blinking CLUTCH light, consider to abort take-off run

**WARNING**

**Before activating the pre-rotator, check area is clear.**

**WARNING**

**Prior to releasing the wheel brake, make sure that the control stick is fully aft, if headwind component allows. A take-off run with flat rotor system may have fatal consequences.**

**WARNING**

**If the rotor speed has decayed to below the green arc, then ground speed must be built-up very carefully to increase rotor speed. Take care! Slow rotors can stall and flap, causing expensive aircraft damage! If in doubt, abort the take-off run and restart.**

**CAUTION**

**Do not engage pre-rotator at high engine RPM or drive the rotor to excessive RPM (especially rotorhead II) as this will lead to pre-rotator drive damage.**

**CAUTION**

**Avoid overtorquing of the pre-rotator drive! Overtorquing will occur if RPM/power is fed excessively or abruptly. In case of a stalling engine, release pre-rotator button temporarily. Do not yank the throttle control while the clutch is engaged!**

**NOTE**

**Perform take-off into the wind and with least possible crosswind component.**

**NOTE**

**To avoid unintended engagement in flight the pre-rotator can only be activated with the control stick in its most forward position, and (if fitted) the canopy locked closed.**

**WARNING**

**In the event of pre-rotator failure, STOP and rectify the fault. Do NOT attempt to pre-spin by hand, as this involves considerable personal risk if the engine is running.**

#### 4.9 Take-off Run

- Check engine has reached full power for take-off. Otherwise, abort take-off
- Commencing the take-off run with high rotor rpm (280-320) and the stick fully back means that there is a high starting drag load. The aircraft has to accelerate to approx. 50mph (depending on loading) to take off, and achieve the rotor rpm for the loading conditions.  
Therefore, to minimise the drag and enable maximum acceleration at high rotor rpm, move the stick forwards to approximately the mid position as the aircraft starts to move. Monitor rotor rpm carefully ensuring that it is increasing, if the stick is too far forwards the rotor rpm will decay, and a serious accident can be caused!
- When nose comes up allow nose wheel to float at about 10 – 15 cm above the runway by a balanced change of control stick position
- Minimize lateral drift by applying appropriate lateral control stick input into cross wind direction
- Maintain directional control i.e. runway alignment with sensitive pedal input
- Maintain attitude until speed increases and gyroplane lifts off (at about 50mph, depending on loading and rotor)
- Allow gyroplane to build-up speed in ground effect

**CSP/VPP:** With a variable pitch propeller installed, refer to the respective flight manual supplement in CHAPTER 9 for correct power setting and handling procedure.

**WARNING**

**Gyroplanes are fully controllable at very low speeds without exhibiting any signs of wing stall or soft flight controls, as it would be perceived in a fixed wing aircraft. However, operation 'behind the power curve' may have fatal consequences during take-off, initial climb or in any other situation within close ground proximity. Always allow aircraft to build-up safe climb speed before allowing it to gain height.**

#### 4.10 Climb

- Perform initial climb at safe climb speed and adjust trim
- Set power to maximum take-off power
- Check engine instruments and respect maximum take-off power time limit
- Switch off second fuel pump at safe height
- At safe altitude, the climb may be continued with  $V_Y$  and reduced power setting for noise abatement
- When desired altitude is approached, level gyroplane and reduce power

**CSP/VPP:** With a variable pitch propeller installed, refer to the respective flight manual supplement in CHAPTER 9 for correct power setting and handling procedure.

#### 4.11 Cruise

- Adjust power setting within the maximum continuous power range
- Adjust trim

**CSP/VPP:** With a variable pitch propeller installed, refer to the respective flight manual supplement in CHAPTER 9 for correct power setting and handling procedure.

#### 4.12 Descent

- Reduce power setting and lower nose
- Adjust trim

**CSP/VPP:** With a variable pitch propeller installed, refer to the respective flight manual supplement in CHAPTER 9 for correct power setting and handling procedure.

#### 4.13 Approach

- Switch ON second fuel pump P2 (if installed)
- Set variable pitch propeller (if installed) to FINE
- Check all warning and caution indications OFF
- Check all instruments in normal operating range
- Check wheel brake unlocked
- Maintain and trim approach speed
- Control glide angle with engine power

**WARNING**

**An approach within the gliding distance to the airport or landing site is generally considered to be the safest option.**

#### 4.14 Landing

- Align gyroplane with rudder and correct drift with lateral control input, even if this results in a side slip indication
- Maintain approach speed until approximately 5m above runway
- Initiate round out to reduce sink rate and let ground approach
- Perform final flare close to ground as speed will decay rapidly
- Let gyroplane settle on main gear with nose wheel slightly above the ground
- Hold nose wheel closely above ground and let it sit down with pedals neutral at the lowest possible ground speed
- Maintain aft control stick to reduce speed until walking speed. Wheel brake may be used to assist, if needed

**CAUTION**

**Touching down with the nose wheel pointing left or right, and with a run-on speed, will cause the wheel to 'grab' in that direction. If left uncorrected the aircraft will try to turn in that direction, possibly resulting in a roll-over. Always lower the nose at low ground speed, with the nose wheel straight.**

**CAUTION**

**When landing in a strong headwind do not use wheel brake to prevent gyroplane from rollback. In order to compensate for any rollback tendency, flatten rotor disc as required and increase propeller thrust, if necessary.**



#### 4.15 Go-around

- Apply take-off power. Counteract yaw tendency and align gyroplane with rudder input.
- In horizontal flight, allow gyroplane to gain speed
- Climb with safe or best rate of climb speed and adjust trim

**CSP/VPP:** With a variable pitch propeller installed, refer to the respective flight manual supplement in CHAPTER 9 for correct power setting and handling procedure.

#### 4.16 After Landing

- Control stick full forward to level-off rotor disc, at latest when rotor speed leaves green arc! Be prepared for reduced rotor drag!
- Use lateral control into wind to maintain rotor disc in level attitude. Adjust lateral control input as rotor speed decays
- Bring pneumatic mode selector to BRAKE position and return to wheel brake with left hand
- Apply rotor brake pressure by using AFT TRIM. Monitor pressure gauge
- Taxi carefully, preferably not above walking speed and mind high centre of gravity when taking turns
- Do not vacate gyroplane until engine and rotor is at a complete stop

#### WARNING

**Mind the spinning rotor and propeller when taxiing close to obstructions or persons. A fast turning rotor or propeller is almost invisible, but contains enough energy to kill a person or cause substantial damage to the aircraft or other structure.**

#### CAUTION

**Try to park the blades fore/aft of the aircraft, to avoid high stick loads in roll when taxiing. Depress the pre rotator interlock release button & engage the pre-rotator to wind the rotor into the desired position. The use of abrupt pedal inputs to do this during taxiing should be avoided.**

#### NOTE

**It is advisable to let the rotor spin down while the gyroplane is at a complete stop. However, in order to vacate the runway, it is possible to taxi while the rotor is spinning down. In this case, be aware of the effects of relative wind on advancing and retreating blade, compensate with lateral control input, and adjust taxi speed carefully as to avoid blade flapping.**

#### 4.17 Engine Shut-down

Throttle .....	Idle
Parking brake.....	Set
Engine cool-down .....	perform
Turbo charger cool-down at 2000rpm (ROTAX 914 engine).....	min. 2mins
Second fuel pump (if installed).....	OFF
Avionics/Radio/Intercom/Lights (except ACL / Strobe) .....	OFF
Both MAG switches sequentially .....	OFF
ACL / Strobe (if installed) .....	OFF
FAN .....	activate if required
Master switch.....	OFF and key removed

#### NOTE

For landing a suitable approach procedure has to be chosen, so the engine cools down sufficiently during descending and later taxiing, as specified by the engine manufacturer. The engine can be shut-off by switching off the ignition; an engine cool-down is not needed.

#### NOTE

Due to the push engine arrangement, a ground engine cool-down is inefficient and may lead to cavitation. If necessary park into wind so that air is driven naturally into the engine bay air intakes.

#### NOTE

If the engine and environment is particularly hot, press the 'Fan' button before turning off the keyswitch to prolong electric engine cooling.

Aircraft fitted with early cowlings without airscoops were optionally fitted with a reverse fan system (MC-194 and/or SB-044). Where installed, pressing the "Fan" button before turning off the master switch will initiate a ground-cooling sequence in which the cooling fan is reversed (to aid natural convection cooling) and then runs for a period of 5-6mins (even when the master switch is subsequently turned off). After this automatic sequence the system will revert to the normal airflow direction for in-flight cooling.

#### 4.18 Parking

- Install rotor lash bag
- Secure gyroplane against rolling using parking brake and chocks, if parked on a slope
- Double check to have master switched OFF and keys removed
- Install protection cover if available or appropriate

**CAUTION**

**Especially in strong winds operate canopy with nose pointed into the wind to eliminate the risk that the canopy is blown open or shut.**

**NOTE**

**Avoid long term parking of the aircraft with empty tanks. This will increase the risk of water accumulation in the tanks and will lead to shrinking of the rubber tank seals.**

#### 4.19 Special Procedure: Short Field Take-off

A short field take off is conducted in exactly the same manner as a normal take-off, but performed with maximum precision. Therefore, a short field take-off is not so much a procedural thing, but needs practice, experience and mentoring. Apart from environmental aspects such as wind and density altitude, the condition of the gyroplane and its gross weight, the key factors for a short take-off performance are:

- Maximum allowed pre-rotation RPM and no time lost until stick is fully aft (if headwind component allows) and brake is released
- Maximum take-off power is set immediately while stick remains fully aft until nose wheel rises
- Nose wheel held tight above surface and minimum side drift until lift-off
- No over controlling that would result in the nose swinging up and down
- $V_y$  climb with no side slip

If Rotorhead III is embodied the procedure is amended to take advantage of higher pre-rotation speed whilst monitoring the “Clutch” warning light.

A short field take-off with high pre-rotation speed puts high loads on pre-rotator and rotor and requires a modified procedure. As a consequence, short field take-offs with high pre-rotation shall only be performed after adequate training and only when necessary.

- Perform normal take-off procedure until clutch is fully engaged
- Carefully increase engine power to maximum, which will give up to 320 R-RPM depending the aircraft loading (at light loading the aircraft may slide forwards with the wheel brakes locked)  
In case of a slipping clutch (CLUTCH light, where fitted), reduce power to match engine to rotor speed
- With the stick moved slightly aft (which will disengage the pre-rotator), release the wheel brake without reducing engine power
- As the aircraft accelerates, move the stick further aft to allow the rotor RPM to increase. Do not let the rpm decrease!
- Allow gyroplane to lift off and gain speed

$V_y$  climb with no side slip

#### 4.20 Special Procedure: Slow Speed Sink and Recovery

- Reduce power to idle and let speed decrease by gently using aft control stick
- Maintain enough forward speed for sufficient rudder effectivity
- Rudder will regain effectivity quickly as soon as airspeed or propeller thrust is increased
- To recover, let nose drop slightly below the horizon and build-up air speed while adding power at the same time

## 4.21 Flight under Conditions of Precipitation

The flight through areas of precipitation is challenging for pilot and gyroplane. Rain or other precipitation can have a negative effect on flight performance of the gyroplane; flight characteristics can be slightly or in extreme situations drastically affected by rainfall. In particular the following must be expected:

- Reduction in, or loss of sight due to wet and / or misted canopy
- Failure or faulty operation of avionics and instrumentation (eg water in the pitot tube)
- Increased wear and tear of some gyroplane components (mainly of the composite propeller leading edge)
- Change of aircraft aerodynamics (mainly under freezing rain)
- Small reduction in performance due to wet rotors.

Avoidance of precipitation conditions should be taken into consideration during flight planning. Should a precipitation area be entered despite correct flight planning, react, if necessary, according to chapter 3 "Emergency Procedures".

### WARNING

**Precipitation is a risk that can be minimized by proper flight planning. Flight through areas of precipitation should be avoided.**

## 4.22 Flight with Summer Canopy

Depending on customer configuration the gyroplane can be configured with a summer-canopy, which features opened canopy sides. Before flying with summer canopy any loose objects must be removed from the cabin or safely stowed.

Removal and installation of the canopy is described in chapter 9-8

### NOTE

**When flying with summer canopy be aware of the strong air stream outside the cockpit.**

## 4.23 Engine In-flight Shut-down and Air Restart

The engine should not be stopped in flight deliberately except as part of forced landing training under the supervision of a qualified flight instructor. If possible, allow the engine to cool down at 3000 rpm for about 30 sec before turning it off.

Make sure both magnetos are switched back ON and the master switch/starter key has been turned to OFF and back to ON to be prepared for an immediate engine start-up in case the manoeuvre has to be aborted.

**NOTE**

**Be aware of reduced rudder effectivity (and increased drag) with a stationary propeller. Be prepared to use larger pedal input and more left pedal than usual to keep gyroplane aligned.**

After a restart, allow engine and oil to warm-up, if possible, before full power is applied.

#### 4.24 Noise Abatement

A positive attitude towards residents and environmental-friendly flying supports the reputation and acceptance of aviation in general, and gyroplanes in particular. When compared to other airplanes the noise of a gyroplane is sometimes perceived as unpleasant although it meets the same or sometimes more stringent noise emission requirements. This effect can be attributed to the pusher concept where the propeller is exposed to air flow which was distorted by the fuselage. The degree of distortion, and therefore the noise emission of the propeller, is significantly lower at reduced speeds. The best practices to keep noise level low and general acceptance high are:

- Climb with the speed for best rate of climb  $V_Y$  as soon as altitude permits
- Especially in climb keep side slip to a minimum to establish a clean configuration. In addition, this guarantees the best climb performance
- For your own safety always maintain safe altitude and avoid unnecessary 'low-flying'
- When overflying populated areas, look ahead and select the least noise sensitive route
- Repetitive noise is far more irritating than a single occurrence. If you must fly over the same area more than once, vary your flight path
- Avoid blade slap (Wop-wop noise). Blade slap can occur as a result of inadequate piloting technique or during aggressive manoeuvres, but will not appear in normal flight regime

**NOTE**

**Above procedures do not apply where they would conflict with Air Traffic Control, within the traffic pattern, or when, according to pilot's judgement, they would result in an unsafe flight path.**

INTENTIONALLY LEFT BLANK

## CONTENTS

5.1	Demonstrated Operating Temperature .....	5-1
5.2	Airspeed Correction .....	5-1
5.3	Height-Velocity Diagram .....	5-2
5.4	Speeds .....	5-3
5.5	Rate of Climb .....	5-4
5.6	Take-off and Landing Data .....	5-4
5.7	Influence on Take-off Distance and Climb Rate .....	5-5
5.8	Sink Rate and Glide Ratio .....	5-8
5.9	Additional Performance Data .....	5-8
5.9.1	Fuel Flow .....	5-8
5.10	Sound Exposure Level / Noise Characteristics .....	5-9
5.11	High Altitude Operation.....	5-9



INTENTIONALLY LEFT BLANK

## SECTION 5 - PERFORMANCE

The following data were determined by flight testing and demonstrated with average piloting skills, with engine and aircraft in good condition, as well as clean main rotor and propeller. The parameters apply to standard conditions (15 °C at sea level and standard pressure) and a gross mass of 500 kg (or 560Kg, as shown).

Note that a higher airfield elevation, increased temperature, low air pressure and/or a take-off mass above 560 kg will have a negative effect on performance.

### 5.1 Demonstrated Operating Temperature

Satisfactory engine cooling has been demonstrated at outside air temperatures up to 40 °C.

### 5.2 Airspeed Correction

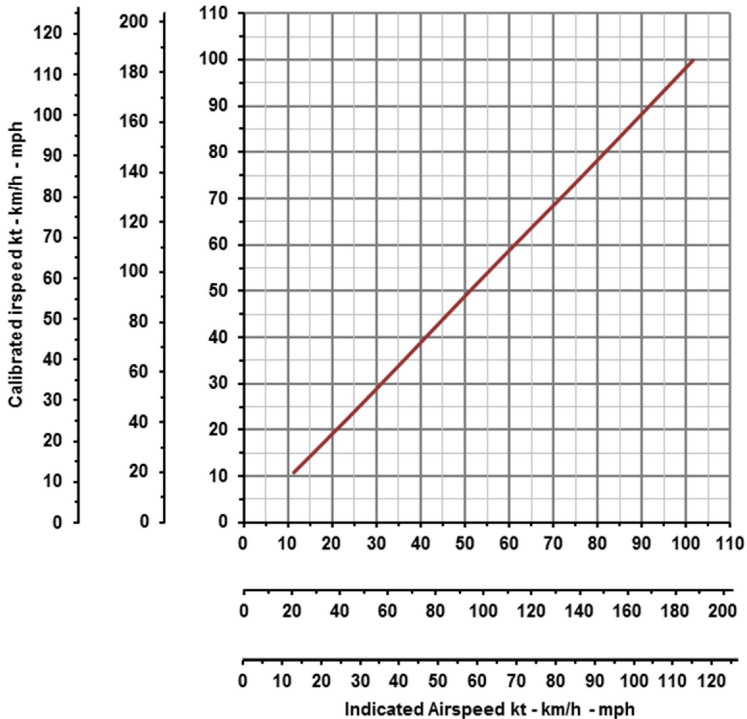

**Example:** Indicated airspeed of 140 km/h represents a calibrated airspeed (corrected for installation error) of 138 km/h.

### 5.3 Height-Velocity Diagram

The H/V diagram indicates combinations of height and speed (avoid area left side of the red graph) where a safe landing may not be possible in case of an engine failure. Therefore, operation on the left side of the red line must be avoided.

Take-offs and landings should be conducted according to the recommended flight profile, provided as blue dashed line.

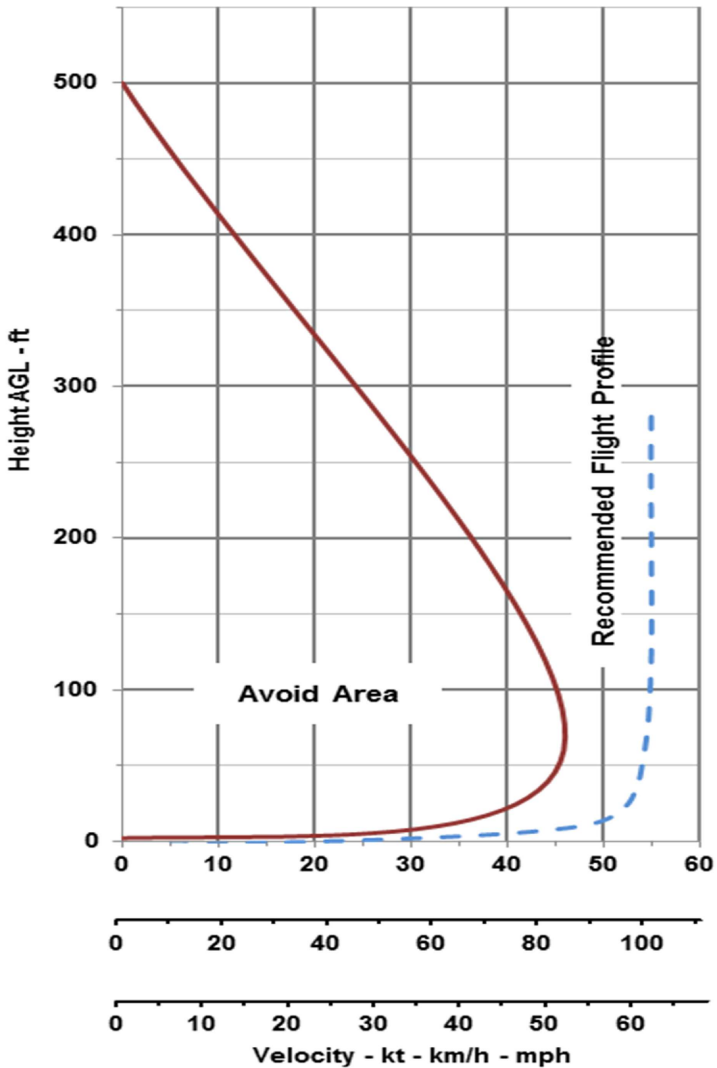

#### 5.4 Speeds

The following speeds are relevant for flight performance. For additional speed limitations refer to SECTION 2 LIMITATIONS of this manual.

Min horiz speed (Vmin), TOP (ROTAX 914)\*, 500Kg .....40 km/h (25mph) IAS

Min horiz speed (Vmin), TOP (ROTAX 914)*, 560Kg .....	55 km/h (35mph) IAS
Min horizontal speed (Vmin), TOP (912), 500Kg .....	55 km/h (35mph) IAS
Speed for best angle of climb $V_x$ .....	100 -110km/h (60-70mph)IAS
Speed for best rate of climb or maximum endurance $V_Y$ ...	90 km/h (55mph) IAS
Best range speed .....	130 km/h (80mph) IAS
Long range speed <sup>***</sup> .....	140 km/h (87mph) IAS
Vmc power-off <sup>****</sup> .....	32 km/h (20mph) IAS
Vmc power on <sup>****</sup> .....	0 km/h (0mph) IAS

\* Take care! A full power operation at Vmin (especially at a low TOW) with a Rotax 914UL will result in a very high nose-up attitude with little forward visibility.

\*\* Long range speed is the speed faster than the best range speed which results in a slightly lesser range but represents a good compromise between range and saved air time.

\*\*\* Approach speed above 60mph builds energy in the rotor that results in a long floating landing. Approach speed at 50mph results in a very short landing roll, and below 50mph requires increasing skill especially at maxTOW.

\*\*\*\*Vmc is the minimum controllability speed. At 20mph or below, engine off, rudder authority reduces, to negligible below 10mph.

TOP is Take Off Power

## 5.5 Rate of Climb<sup>2</sup>

Rate of climb, 500 kg, $V_Y$ , TOP, 914UL .....	3.6 m/s (700fpm)
Rate of climb, 560 kg, $V_Y$ , TOP, 914UL .....	2.8 m/s (550fpm)
Rate of climb, 500 kg, $V_Y$ , TOP, 912ULS .....	2.5 m/s (500fpm)
Rate of climb, 500 kg, $V_Y$ , MCP .....	3.4 m/s (660fpm)
Rate of climb, 450 kg, $V_Y$ , MCP .....	4 m/s (780fpm)
Rate of climb, 360 kg, $V_Y$ , MCP .....	6 m/s (1170fpm)

## 5.6 Take-off and Landing Data

Take-offs and landings have been demonstrated up to a crosswind component of 36 km/h.

The following data is valid for operation at a gross mass of 450 kg at an even air strip with short grass, no wind, and pre-rotation to 220 RPM. Take-off and landing distances account for a 15m obstacle.

Take-off roll* .....	80 – 120 m
Take-off distance* .....	300 m (975ft)

\* Take-off roll and take-off distance will be shorter using the boost regime of the ROTAX 914 engine

<sup>2</sup> Rate of Climb values were identified within noise measurement according to German regulations and may differ from the listed values depending on engine and propeller type.

Landing roll .....	0 – 20 m (0-65ft)
Landing distance from 15m (still wind) .....	200 m (650ft)
Landings within 100m or less can be made with practice.	

The following data is valid for operation at a gross mass of 500 kg at an even air strip with short grass, no wind, and pre-rotation to 220 RPM. Take-off and landing distances account for a 15 m obstacle inclusive of a 1.5 safety factor over distances demonstrated in test.

Take-off roll.....	140 – 220 m (455-715ft)
Take-off distance, 914 UL HTC prop .....	460 m (1495ft)
Take-off distance, 914 UL IVO .....	390 m (1267ft)
Take-off distance, 912 ULS HTC prop.....	550 m (1787ft)

As an additional information the following data is valid for operation of a Calidus equipped with an ROTAX 914 UL engine, at a gross mass of 560 kg at an even air strip with short grass, and pre-rotation to 200 RPM. Take-off distances are to clear a 15 m obstacle, inclusive of a 1.3 safety factor over distances demonstrated in test.

Take-off roll.....	160 – 250 m (520-812ft)
Take-off distance, 914 UL HTC prop, pre rotated to 200rpm .....	685 m (2226ft)
Take-off distance, 914 UL IVO, pre rotated to 320rpm .....	424m m (1378ft)
Take-off distance, 914 UL IVO, pre rotated to 200rpm .....	598m m (1445ft)

Typically the fitment of an in-flight variable pitch propeller set to full fine will reduce take-off distance by 15%, by comparison to the HTC fixed pitch prop, due to the increased static thrust that is generated.

These distances depend on the aircraft take-off weight and environmental conditions. Reduced weight reduces take-off distance, and the environmental effects are shown in the 2.2 paragraph. Wet grass or boggy conditions will significantly increase these distances

#### **Crosswind data**

Take-offs and landings have been demonstrated up to a crosswind component of 36 km/h (22mph).

### **5.7 Influence on Take-off Distance and Climb Rate**

All flight performance figures presented in this chapter are based on standard atmospheric conditions in sea level. Depending on actual temperature and pressure altitude (elevation) factors on take-off distance and climb rate can be deducted from the following chart.

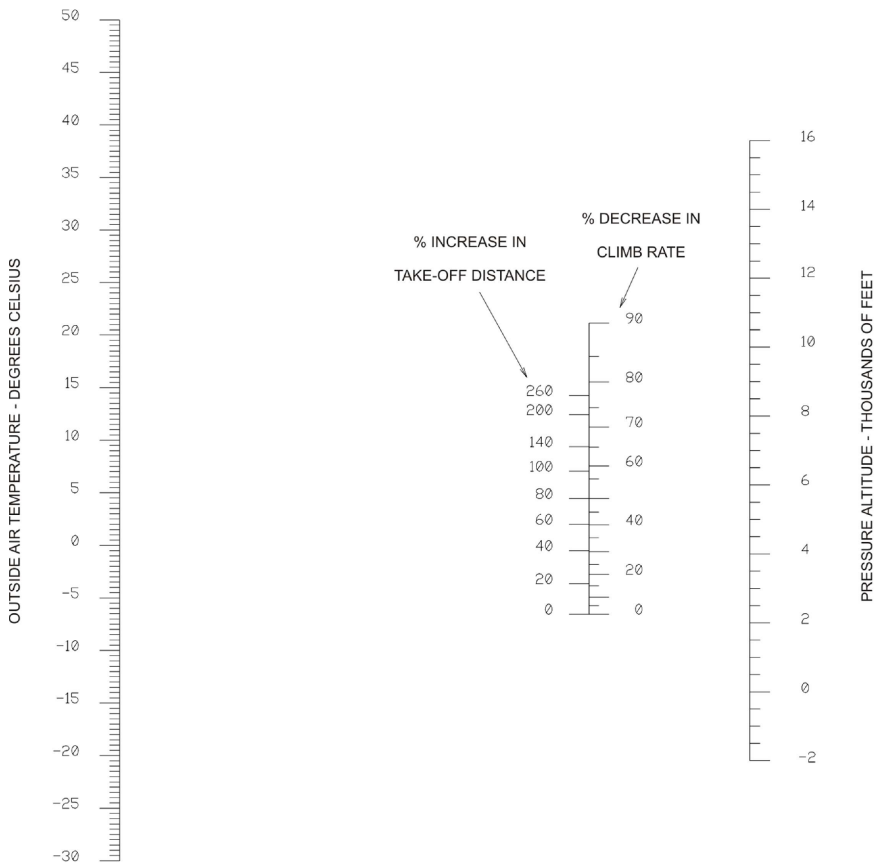

See next page for example.

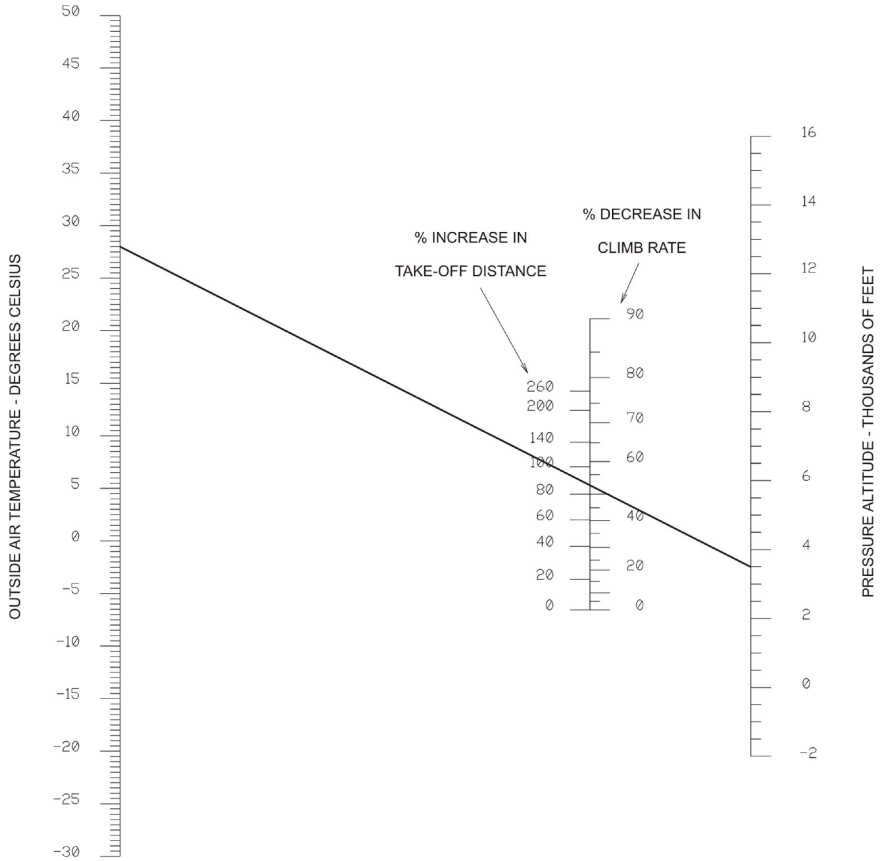

**Example:**

Given: Outside Air Temperature 28 °C and Pressure Altitude 3500 ft  
 Result: 88 % increase in take-off distance and climb rate reduced by 53 %



## 5.8 Sink Rate and Glide Ratio

The sink rate depending on airspeed with the engine in idle is plotted in the following diagram:

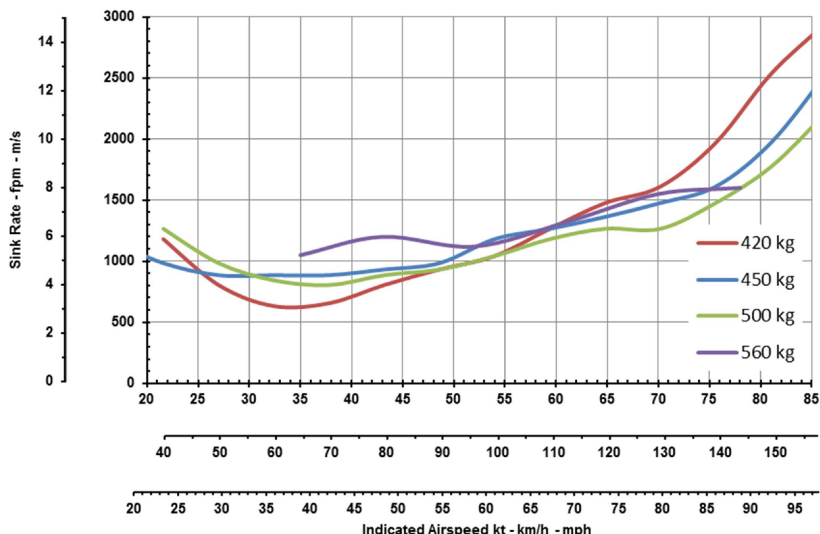

In case of an engine failure, expect a glide ratio of 1:3 which corresponds to a vertical distance of 900 m or 0.5 nautical miles for each 1000 ft.

## 5.9 Additional Performance Data

### 5.9.1 Fuel Flow

The following fuel flow figures are provided as estimates at nominal aircraft loading and do not constitute certified performance. Exact fuel flow will vary with engine choice, operating weight, environmental conditions, cleanliness of propeller and rotor, piloting technique (minimum side slip), and power setting. For additional procedures about proper power setting consult SECTION 9 for supplemental data concerning the variable pitch propeller, if installed.

See also the Rotax Operators manual, which shows engine fuel consumption at different power settings.

Fuel flow at 130 km/h (80mph) IAS, level flight ..... 13-15ltr/h

Fuel flow at 160 km/h (100mph) IAS, level flight ..... 18 ltr/h

### 5.9.2 Service Ceiling

See SECTION 2 LIMITATIONS

### 5.10 Sound Exposure Level / Noise Characteristics

The noise certificate was granted according to the German requirements for noise protection for microlight gyroplanes ("Lärmschutzverordnung für Ultraleichte Tragschrauber") stating an overfly noise of 68 dB or less.

### 5.11 High Altitude Operation

The reducing air density climbing to this altitude means that the engine will be prone to over revving. Throttle back, or increase propeller pitch (where a variable pitch propeller is fitted).

Rotor rpm will rise by approximately 90rpm. This will increase disc inertia, and may affect the rotor vibration. The rpm will easily rise above this value at Vne or in turns. Ensure the rpm remains within gauge limits.

Engine oil or coolant systems may be compromised by the lack of air density to remove the heat. Ensure T's and P's remain within limits.

Ensure the aircraft remains within the handbook operating temperature limits; ISA standard at 12,000ft is approx. -13degC, the aircraft is approved to -20degC.

Ensure occupants are properly equipped for operation at this altitude – especially for the low temperature, and for the lack of oxygen.



## CONTENTS

6.1	General .....	6-1
6.2	Weight and Balance Record .....	6-1
6.3	Compliance with Weight and Balance.....	6-1



INTENTIONALLY LEFT BLANK

## SECTION 6 - WEIGHT AND BALANCE

### 6.1 General

The gyroplane must be operated within the weight and balance limits as specified in SECTION 2 of this manual. Loading situations outside these limits can result in restricted flight control and can ultimately lead to degraded safety.

### 6.2 Weight and Balance Record

An initial weighing report and equipment list showing gyroplane configuration, empty weight and centre of gravity is delivered with each gyroplane. This data applies to the gyroplane as delivered from the factory. Any changes in the configuration should be performed by a qualified maintenance station and documented. After modifications and at regular intervals a new weighing report and equipment list should be issued.

### 6.3 Compliance with Weight and Balance

The Calidus gyroplane is designed in such way that compliance with weight and balance is provided, if

- the gyroplane is loaded within the individual weight limitations for each station as provided in SECTION 2 of this manual, and
- the maximum allowable cockpit loading (both seats and baggage) is respected, and
- the certified maximum take-off weight, representing the total sum of pilot, passenger, baggage, fuel and current empty weight is not exceeded



INTENTIONALLY LEFT BLANK

## CONTENTS

7.1	Introduction.....	7-1
7.2	Airframe and Undercarriage.....	7-1
7.3	Doors, Windows and Exits.....	7-1
7.4	Fuel System .....	7-1
7.5	Pneumatic System.....	7-4
7.6	Power Plant.....	7-5
7.7	Propeller.....	7-6
7.8	Rotor System.....	7-7
7.9	Vibration Damping.....	7-10
7.10	Flight Controls .....	7-11
7.11	Electrical System .....	7-17
7.12	Lighting System.....	7-18
7.13	Avionics.....	7-18
7.14	Instrument Panel .....	7-18
7.15	Intercom .....	7-25
7.16	Pitot Static.....	7-25
7.17	Indicators and Sensors.....	7-25
7.18	Seats and Seatbelts .....	7-26
7.19	Stowage Capacity.....	7-27
7.20	Fire Warning System .....	7-27
7.21	Fuses .....	7-27
7.22	Cabin heater.....	7-30



INTENTIONALLY LEFT BLANK



## SECTION 7 - SYSTEM DESCRIPTION

### 7.1 Introduction

This section contains the description of the gyroplane and its standard systems and equipment. Optional equipment is described in Chapter 9 of this manual.

### 7.2 Airframe and Undercarriage

The load carrying structure of the gyroplane consists of a composite monocoque occupant enclosure, bolted to an inert-gas welded stainless steel tube framework including tower and aft extension. The composite structure and main frame carries all loads induced by the crew stations, engine, rotor, undercarriage, stabilizer, and serves as installation platform for additional equipment.

Stabilizer structure with rudder is made of GRP (or in certain cases CRP) and is bolted to the aft extension of the main frame. Attachment points for the engine installation are provided by a steel tube ring mount at the rear of the mast, which also supports the rotor at its top end.

The landing gear consists of a steerable nose wheel in a steel fork and two main wheels with hydraulic brake system. Both main wheels can be equipped with wheel spats made from GRP and are mounted to the ends of the spring spar, which is made from GRP. The spar is designed to absorb even higher than normal landing loads in case of a hard landing or crash.

### 7.3 Doors, Windows and Exits

This gyroplane features one large undivided plexiglass canopy which is hinged at its left hand side and has a locking mechanism on the right hand side. The locking mechanism can be operated from the inside and outside by lifting the operating lever. The canopy is properly locked when the detent interlocks with the locking pin bushing and the lever is parallel to the canopy frame. Note that a firm force is needed to ensure the detent interlocks fully in order to lock the canopy properly.

Two adjustable fresh air vents on the right hand side and one sliding window with pivoting vent are provided for ventilation. The sliding window can be used as viewing hatch in case of emergencies and is wide enough to reach through with a hand.

The gyroplane is embarked and disembarked from the right hand side while the canopy is held open by a restraint strap. In case the canopy cannot be opened, use the emergency hammer located at the left hand side of the pilot station to break the Plexiglas and evacuate.

### 7.4 Fuel System

The fuel system consists of one or two tanks, a single filler port, fuel and ventilation lines, fuel level indication system, and drain. The filler port is located at the left hand side of the gyroplane. In order to open the (optionally lockable) filler cap, lift, then turn the flap, and pull out. Reverse to close cap. The cap is optionally retained to the aircraft via a security cable. This cable is deleted in later aircraft, because the risk to fly with

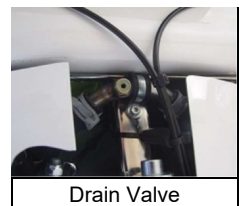

Drain Valve

the cap hanging on the cable, and flying through the prop is considered greater than flying without a cap.

The main tank is installed behind the aft seat in the left hand side and has a capacity of 39 litres. Fuel level is indicated by a transparent sight line with markings and also by a fuel quantity indicator in the cockpit.

As an option an additional tank with a capacity of 36 litres may be fitted on the right hand side. In this case a crossover line connects both to ensure equal level. In order to top-off tanks it is recommended to fill-up slowly and to allow flow levels to balance-out as the cross-over flow rate is limited.

Both tanks are ventilated by a ventilation line above the tanks, downwards to the lower engine cowl. Fuel hoses are made of fabric-reinforced rubber.

As an option, a low fuel sensor may be installed. The LOW FUEL warning light is triggered as soon as 5 litres or less of useable fuel remain in the tank.

The fuel system versions differ with engine model, see schematics below.

#### Fuel system ROTAX 912:

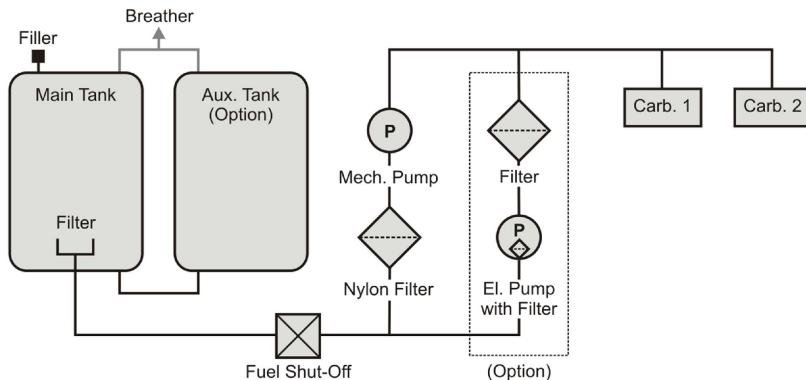

#### Fuel system ROTAX 914:

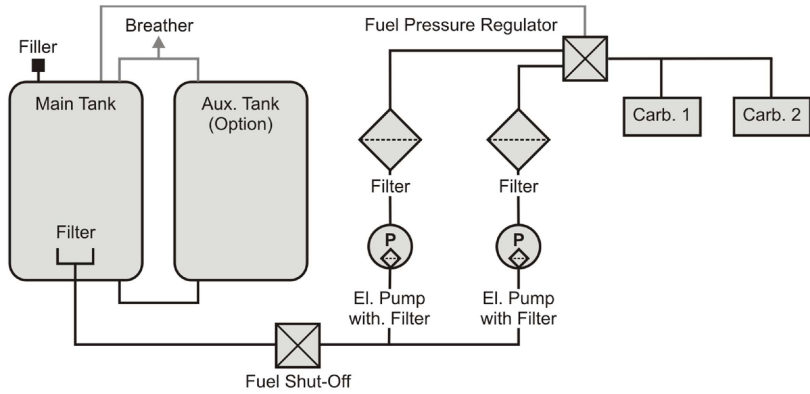

## 7.5 Pneumatic System

Aircraft trim, rotor brake and activation of the pre-rotator is controlled by a pneumatic system, consisting of an electrically driven air compressor with filter/dryer, a pressure gauge in the cockpit, solenoid valves, air lines, pneumatic actuators, and the respective cockpit controls.

### Trim function

Trimming is affected by varying trim pressure in the pneumatic trim actuator which is installed in parallel with the rotor head tilt for pitch control. Aft or nose-up trimming activates the electrical compressor and increases trim pressure, causing the actuator to retract, and tilting the rotor disc aft. Forward trimming opens the pneumatic valve to reduce trim pressure and allows the rotor disc to flatten, due to the spindle head offset and the gyroplane's weight. The actual trim condition is indicated on the trim/brake pressure gauge in the centre panel of the cockpit.

Lateral/roll trim is available as an option and works accordingly, using a lateral pneumatic trim cylinder. With this option installed, lateral trim condition is indicated by a LED bar on the instrument panel.

### Rotor brake

With the pneumatic mode selector in BRAKE position the operation of the pneumatic trim actuator is reversed so that increased pressure causes the actuator to push the rotor head up (or level) and presses a brake pad against the rotor head disc (and in the case of Rotorhead III, also engages the front brake pad). In order to increase brake pressure, move the 4-way trim switch to aft. Note that this action will also push the control stick forward. At full brake pressure the control stick will be maintained in its full forward position.

### Activation of the pre-rotator

The pre-rotator is activated as long as the respective switch on the control stick head is depressed provided the following pre-conditions are met:

- pneumatic mode selector set to FLIGHT
- control stick in full forward position
- trim pressure less than 3 bar
- "Canopy" light OFF (if installed, means that the canopy is closed and locked)

When activated the pneumatic clutch is activated and engine torque is transmitted through a 90° gearbox and drive to the pinion which is engaged by another small pneumatic actuator into the geared ring of the rotor head. The drive pinion is sliding on a helical gear to provide automatic lock-out in case of rotor RPM overrun. The pre rotator drives shafts feature sliding splined elements to accommodate drive shafts length changes due to rotor head and engine operational movement.

### Activation of the pre-rotator in BRAKE position

The pre-rotator can be activated in BRAKE position to park the rotor blades fore-aft for taxi. To do so, the pre-rotator switch and the overdrive/override switch in the cockpit panel have to be pressed simultaneously. Avoid prolonged activation of the pre-rotator with rotor brake engaged.

## 7.6 Power Plant

### Engine

There are two engine variants available, being the ROTAX 912 ULS normally aspirated reciprocating engine and the ROTAX 914 UL turbo charged version. Both engine types are 4 cylinder, horizontally opposed, 4 stroke engines featuring

- Liquid cooled cylinder heads
- Ram air cooled cylinders
- Dry sump forced lubrication
- Dual breaker-less capacitor discharge ignition
- 2 constant depression carburetors
- Hydraulic tappets
- Electric starter
- Generator (Alternator)
- Reduction gearbox with integrated shock absorber and overload clutch

The ROTAX 912 ULS engine provides a maximum take-off power of 100 horse power while the turbo charged version offers a maximum take-off power of 115 horse power. For technical details refer to the engine manufacturer's manual.

### Oil system

The oil reservoir with dipstick is accessed through a cover on the right hand side of the fuselage. The cover is held by 3 cam lock fasteners (either butterfly or cross head type) which can be locked or unlocked by a quarter turn. The type of lubrication system requires a special procedure for accurate oil level checking and to prevent overfilling, which is described in SECTION 8 of this manual.



Oil tank access panel

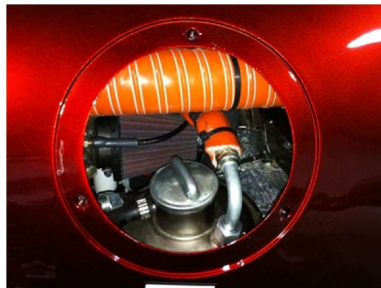

Access panel removed (early aircraft shown)

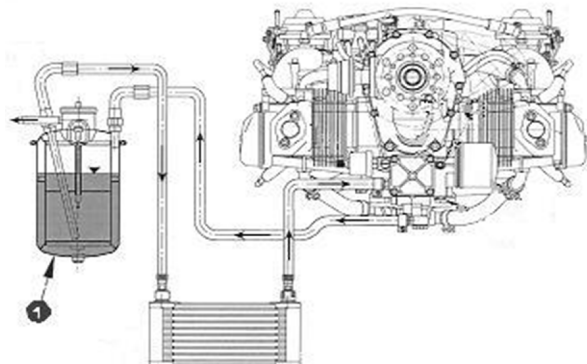

This picture shows the principle of the oil system, as shown in the Rotax handbook. For this aircraft a thermostat is included within the oil system, fitted between the engine and the radiator.

### Engine cooling

Engine cooling is provided by ram air cooled cylinders and liquid cooled cylinder heads. Therefore, cylinder head temperature (CHT) or coolant temperature (CT) indication (depends on cylinder head design) is provided in the cockpit. Sufficient cooling air flow is provided by a ram air duct. The water cooling system comprises of engine driven pump, radiator with thermo-activated electrical blower fan, expansion tank with radiator cap, overflow bottle, and hoses.

A single, large area radiator is mounted above the engine so that cooling air from the ram air duct passes through the cooler, is directed around the engine's cylinders, and finally escapes through an opening at the lower rear end of the engine cowling. Force cooling is ensured by an electrically driven ducted fan controlled by a thermo switch. A push button in the cockpit allows manual activation temporarily which is typically used to avoid possible heat build-up after shut-down.

Two versions of engine cowling are fitted. The later type has improved ducting for better cooling.

In order to support natural heat circulation (chimney effect) with the early cowlings fitted, the blower fan reverses in ground mode to allow the hot air escape at the ram air opening in the forward mast cover. Ground mode is detected when the engine is off. This is an optional fitment.

The cooling system is thermostatically controlled, such that coolant only passes through the radiator when the coolant temp reaches the required value. The coolant circuit also supplies the interior mounted heater system. This coolant bypasses the thermostat such that heat reaches the cabin before the coolant temperature activates the thermostat.

For the relevant checking and replenishing procedures, refer to SECTION 8 of this manual and also the engine manufacturer's manual.

## 7.7 Propeller

A three-bladed, fixed pitch propeller with aluminium hub is used as standard version. The propeller blades are made from composite material with a foam core. As an option a variable pitch propeller is available which is described in SECTION 9 of this manual.

## 7.8 Rotor System

The two-bladed, semi-rigid, teetering rotor system comprises high-strength aluminium extruded rotor blades, a hub bar, and a common teeter hinge assembly.

The rotor blades feature an aerodynamic profile especially suitable for rotorcraft which, in combination with its relative centre of gravity, provides aerodynamic stability by eliminating negative blade pitching moments and flutter tendency. The hollow blade profile is sealed at both ends by plastic blade caps.

The aluminium rotor hub bar is pre-coned to the natural coning angle of the blades and connects the blades firmly to each side using 6 fitting bolts and a clamping profile. In order to compensate for asymmetric air flow in forward flight the blades are free to teeter. The hinge assembly consists of teeter tower, teeter bolt and teeter block.

The teeter bolt runs in a long Teflon coated bushing in the teeter block (main bearing action), as well as two shorter bushings in the teeter tower (emergency bearing action). The main bearing action is supported by special grease which is applied through a grease nipple on top of the teeter block. Servicing is described in SECTION 8 of this manual.

Three generations of rotor and rotorhead are in service on Calidus.

1. Orange end cap rotorsystem I and short teeter tower, from first build. Stainless steel rotorbridge.
2. RotorSystem II with 'tall' teeter tower. Same rotorhead construction.
3. RotorSystem II with Rotorhead III. Released in 2018. Characterised by a short teeter tower and teeter block (the rest of the rotorsystem is RSII), and totally new rotorhead construction. Permits pre-rotation up to 320rpm.

View of Rotorsystem I rotor assy and installed in rotorhead

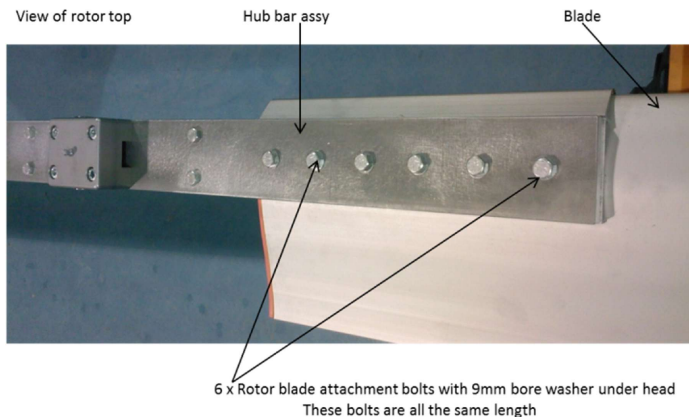

Teeter bolt with split pin

Dot marks

Teeter stops

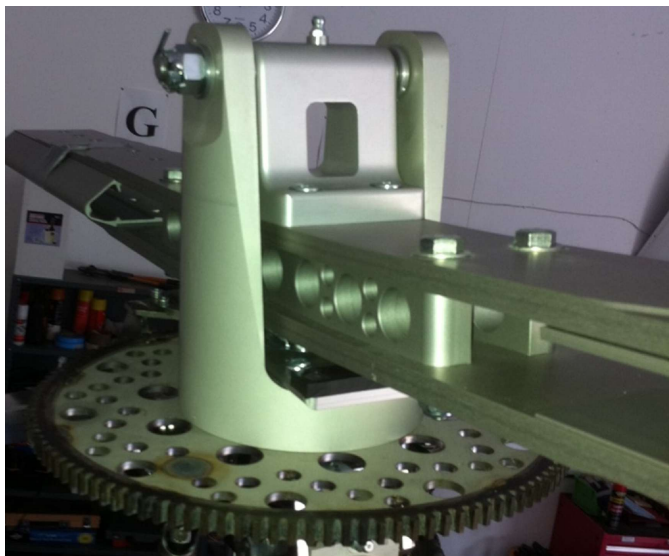
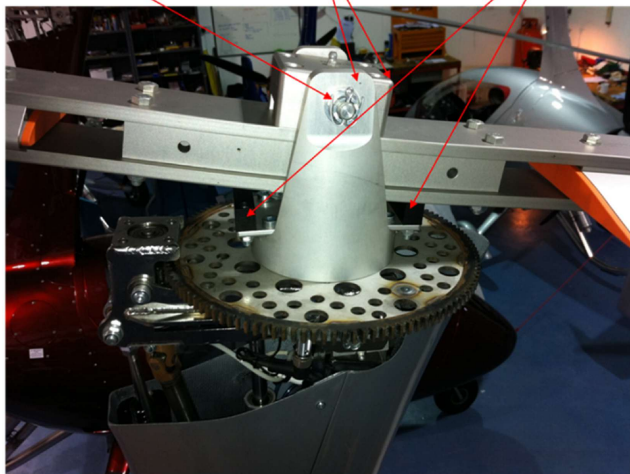

View of RotorSystem II fitted (rotor blades not installed). Note the taller tower.



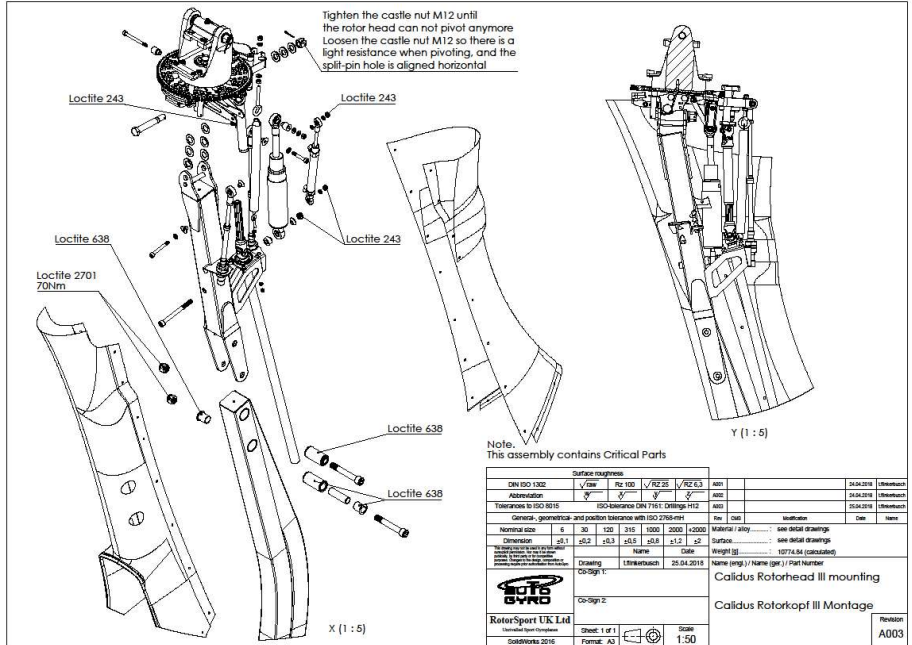

Rotorhead II, as shown in the above drawing, is entirely new from the mast flexible joint upwards.



View of Rotorhead III installed. Note the addition of a trim spring, which should be nearly slack with the head against the rear pitch stops. Rotor head side plates are '21.5mm' for Calidus.

## 7.9 Vibration Damping

A certain level of vibration is inherent to any 2-bladed rotor system. In order to reduce vibration levels to a minimum, a vibration decoupling element (rubber bushes) in the rotor mast isolates rotor vibration from the fuselage.

With rotorhead III the lower bush is replaced by a solid bushed bearing. The upper bush remains rubber.

### Rotor vibration damper

On early aircraft a single damper may be located between the rotor head and the mast to dampen out any residual vibration between the rotor and the control stick. This is adjustable by turning the lower adjustment knob anticlockwise for less or clockwise for more damping, with 6 position notches. The position may be adjusted to suit the pilot requirements. A stiffer

setting will reduce vibration, but give a heavier feel to the aircraft handling - good for long distance cruising. A light setting will increase vibration, but give a light feel to the aircraft - great for general handling.

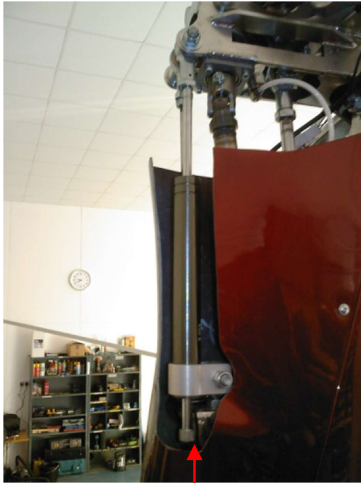

Damper                      Adjust here

This unit was only fitted to early aircraft, being superseded by the performance of Rotorsystem II and later developments.

## 7.10 Flight Controls

### Rotor head and trim control

Pitch and roll of the gyroplane are controlled by tilting the complete rotor head by means of the control stick. Control input is transferred via torsion tube and linkage running below the seats to the base link and from there to the rotor head via push-pull control cables.

The control stick head is ergonomically shaped to fit the pilot's right hand and features control buttons for radio transmission (1), a four-way trim function (2), and activation of the pre-rotator (3).

The trim control works as a classical 4-way beep switch. Pulling the beep switch back increases aft trim or nose-up tendency, while pushing the switch forward reduces back trim pressure, leading to a nose-down tendency. Roll trim (if installed) is effected by pushing the trim switch to the respective side.

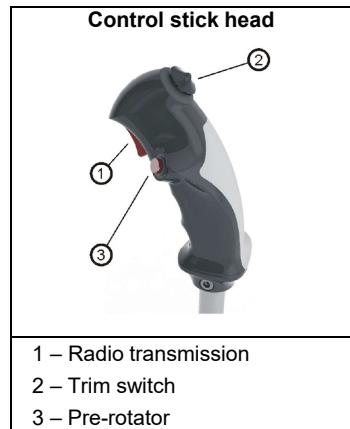

Because of a safety circuit, activation of the pre-rotator is only possible with the pneumatic mode selector in FLIGHT position and the control stick fully forward. This prevents inadvertent activation of the pre-rotator during flight or in BRAKE mode.

Two versions of grip are in use in Calidus.

1. G205 foam grip



2. AutoGyro 'Comfort' grip



The aft stick is held by means of 2 bolts, self-locking nuts and a pair of distance washers within a bracket and should be removed unless the seat is occupied by a qualified flight instructor.

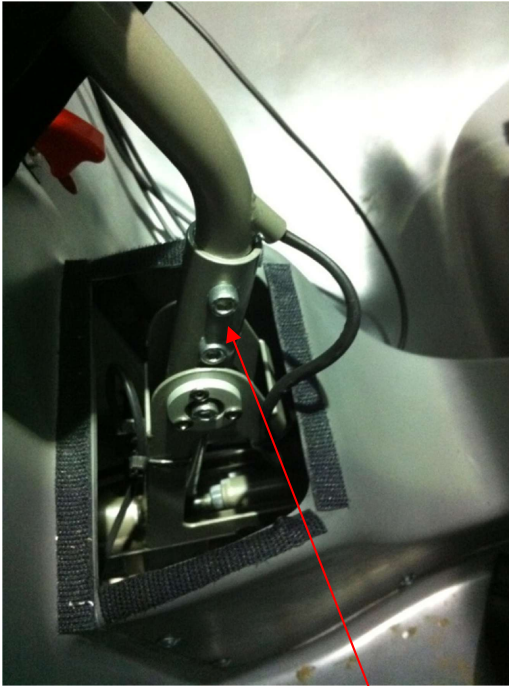

View of the two rear stick attachment bolts. After re fitting ensure that electrical cable does not foul on the edge of the stick aperture on extremes of control stick movement.

#### CAUTION

When the front seat back is adjusted rearwards it is possible for the rear stick grip to contact the back of the front seat, restricting the forward pitch movement of the rear stick. In some markets removable stops are fitted to the front seat adjustment straps to limit travel and prevent this issue.

Where the rear stick is fitted, always ensure that the front seat back is adjusted so that there is no pitch forward restriction - before starting the engine!



View of strap limit stop stops fitted – comprise 2 washers, screw and nylock nut per strap.

### Rudder and front wheel control

The Rudder is connected to the foot pedals with steel cables which are routed horizontally along the main frame. Both pairs of pedals are interconnected by a linkage. The nose wheel steering is directly linked to pedal/rudder control input by control rods. The rear pedals are an option fit item for instructional use.

The rudder is fitted with a trim tab.

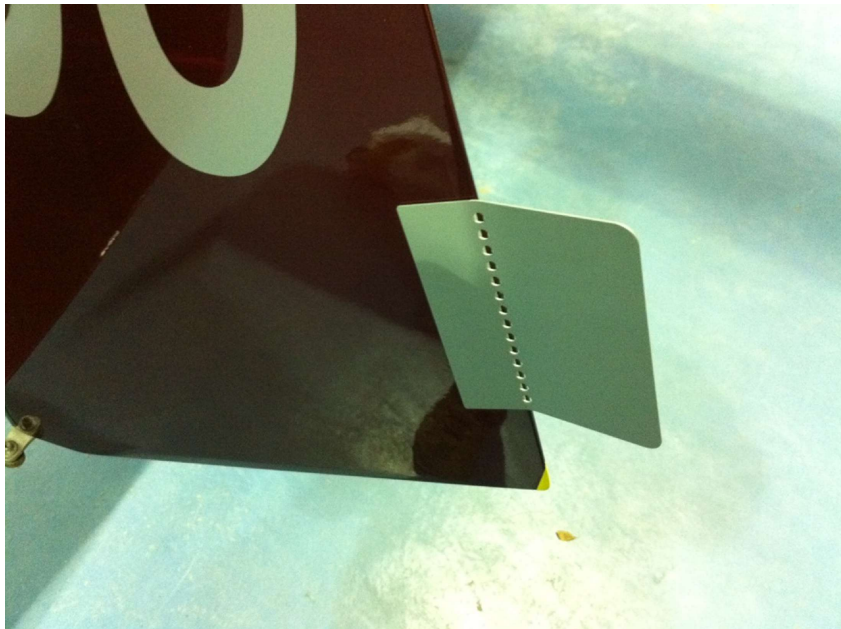

This is normally biased to the left, and may be adjusted by the operator to trim the aircraft for straight flight at a desired speed, feet off the pedals. Adjusting it to the left will bias the rudder to the right and vice versa.

### Throttle and brake quadrant

The throttle and brake quadrant with choke is located on the left side of the pilot station. Throttle control (1) is conventional with IDLE in aft (or pulled) and full throttle in most forward position. With the ROTAX 914 UL engine the boost range is entered by overcoming a small resistance to the front. The throttle lever is linked with cable controls to the carburettors. A mechanical spring applies tension to the control cables and brings the carburettors to full throttle in case of a cable break. The throttle lever has a pre-set friction brake which holds the throttle in the selected position.

Choke (3) is used start a cold engine. In order to do so, pull the choke lever fully to the rear or ON position and be sure to have the throttle in idle position. After starting the engine and a short warm-up, the choke can be slowly disengaged by moving the lever into its forward or OFF position.

The hydraulic wheel brake is actuated by pulling the brake lever (2). A locking pawl mechanism allows setting for use as parking brake. In order to release the parking brake pull the brake lever a little further to let the spring-loaded locking pawl disengage, and then release wheel brake.

Do not try to disengage the locking pawl by pressing the small release lever without pulling the brake lever at the same time. Releasing the pawl using the small release lever only will lead to premature deterioration of the teeth. If the teeth are worn the function of the parking brake will be compromised!

The throttle and brake quadrant also supports the brake fluid reservoir (4) with screw cap and fluid level minimum and maximum markings, as well as the primary brake cylinder (5).

Brake fluid is DOT4.

The rear cockpit is may be fitted with a throttle and brake lever for instructor use. The rear cockpit may also be fitted with magneto cut-off switches.

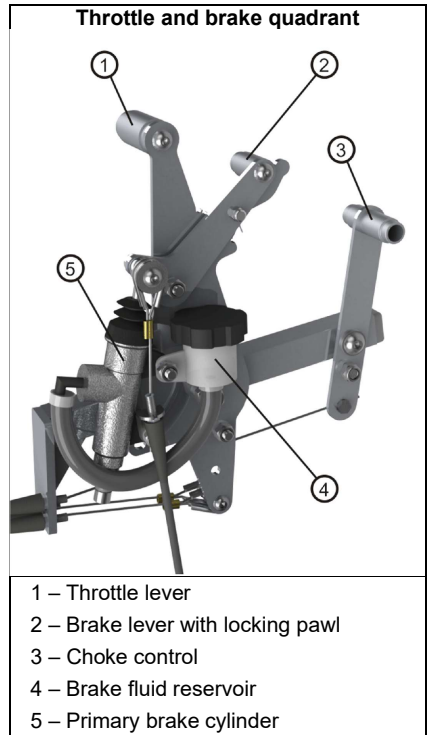



Rear seat headset mounting with instructor kill switch option fitted.



Throttle Brake  
Rear seat throttle and brake instructor pack



## 7.11 Electrical System

The 12V DC electrical system consists of an engine driven electrical generator, a battery, master switch, indicators, switches, electrical consumers, and cabling. With the ROTAX 914 UL engine an electrical power supply is vital for continued engine operation as this engine variant solely relies on electrically driven fuel pumps.

An additional externally mounted 40A generator (Gen2) is available.

Turning the master switch to the ON position closes the battery contact and energizes the gyroplane's electrical system. The red LOW VOLT warning light will illuminate briefly as a functional check. A steady indication, however, warns the pilot that the voltage of the system has dropped below a safe value. In this case a safety circuit (load shedding relay) will automatically disable the aircraft lights and the 12V power receptacle. The lamp may remain illuminated until sufficient voltage exists, and may be until after engine start.

A red GEN warning light is installed to indicate that the battery is not being charged.

The power consumption of individual equipment is listed in the following table:

Equipment / System	Power load
<i>Generator</i>	<i>(-) 240 W</i>
Electrical fuel pump	21 W
Pneumatic compressor	124 W (peak) / 103 W
Engine cooling fan	194 W (peak) / 97 W
Strobe lights	28 W
NAV lights (LED)	9 W
Landing light (LED)	7 W
Radio ATR500	2 W (rcv) / 35 W (xmt)
Radio ATR833	7 W (rcv) / 35 W (xmt)
ATC Transponder TRT800H	max. 10 W
Garmin 695 / 795	40 W
Flymap F7 / Sky-Map T7	5 W
Flymap L	35 W
Flymap L (dual screen)	70 W
Flymap XL	45 W

### WARNING

High electrical load in flight with low engine rpm may reduce the ability of the charging circuit to replenish the battery, thereby reducing the battery reserve in the event of a charging circuit failure. Illumination of the LOW VOLT warning lamp lights demonstrates that the electrical system voltage has dropped below 12v, and, provided the charging circuit is working, that the electrical demand has exceeded supply. If lit, or intermittently lit, either reduce the electrical load or increase generator circuit output by increasing the engine rpm, as safe or appropriate to do, such that the lamp remains off.'

## 7.12 Lighting System

The aircraft is approved for day VFR operation only. Position lights, landing light and strobes are available as optional equipment. If installed, refer to SECTION 9 of this manual.

## 7.13 Avionics

Radio.

Option fit is the Funkwerk ATR833, Mkl approval no EASA.210.0193, MkII approval number EASA.210.10062108 for both external and internal communications. This replaces the Funkwerk ATR500 radio (not compliant with 8.33MHz requirements). The wiring harness terminates in a standard jack plug type connection at each seat, and the antenna may be mounted inside the nose, or underneath the enclosure. Ensure the headsets chosen function correctly before flight, and refer to the radio's User Manual.

The radio EASA approval numbers are, Mkl approval no EASA.210.0193, MkII approval number EASA.210.10062108.

Transponder.

Option fit is a Funkwerk TRT800H Mode S transponder. The antenna protrudes under the body. Read the User Manual for operational instructions, and take care that the Mode S hexadecimal code and aircraft recognition data is correct!

The Funkwerk TRT 800H carries an EASA approval, approval no. EASA.210.269

Others may be fitted subject to local approval.

Remark; Depending on the market, a Radio Operators licence may be required to allow use of the radio, and a Radio Installation licence may be required for the radio and transponder (eg one combined licence, renewed annually).

## 7.14 Instrument Panel

Different instrument panel layouts are available. The basic instrumentation arrangements include:

- Standard Layout
- Moving Map Landscape
- Moving Map Portrait
- Glass Cockpit

The standard layout includes all instruments necessary for flight but also installation provisions for additional conventional instrumentation.

The panel layouts Moving Map Landscape or Portrait include all relevant instruments arranged in a way to accept most off-the-shelf moving map navigation devices in the respective format. For detailed user information and instructions concerning the different moving map systems please refer to the manufacturer's documentation.

### NOTE

**Any moving map system shall be used for reference only and does not replace proper flight planning and constant oversight and awareness.**

**WARNING**

All GPS and/or EFIS display units requires regular updating of the hardware and software, and of the maps. It is the operators responsibility to ensure the equipment is correctly updated prior to flight, and to understand that the GPS system is NOT a primary navigational aid. The GPS system (or any other information displayed on the device) has not been approved to any airworthiness standard.

**WARNING**

Handheld and panel mounted GPS units are protected from the aircraft, and vice versa, by the inline fuse in the unit power supply lead (normally the plug that fits into the aircraft aux power socket). Never operate with the fuse bypassed, otherwise a malfunction in the unit may lead to an electrical fire.

Some GPS units and antennas emit magnetic fields that vary with respect to time and/or levels of battery charge. These may change your compass deviations, so always cross check between the compass headings with your GPS installed and placard accordingly if required

The Glass Cockpit layout is tailored to the integrated flight and navigation suite DYNON AVIONICS SkyView. In addition to navigational and moving map functions, the system provides primary flight data and engine/vehicle monitoring. It is of utmost importance to read and understand the operator's manual and to become familiar with the system before operation. In case of a system failure, a 2 ¼" (47mm) altimeter, air speed indicator and rotor speed indicator are provided as back-up instrumentation.

Depending on the chosen instrumentation and optional equipment, the depicted panels on the following pages may vary.

Various compasses may be fitted to suit different markets – for instance, only PAI-700 card compasses are supplied to the UK market.

The AirSpeed Indicator and Altimeter are normally analogue instrument. Later generation panels may be fitted with electronic ASI and Altimeters, manufactured by AutoGyro. These each contain a backup battery, which will last, if charged, in excess of 30minutes. The units may be turned on and off independently of the aircraft power supply.

Panel Layout - Standard

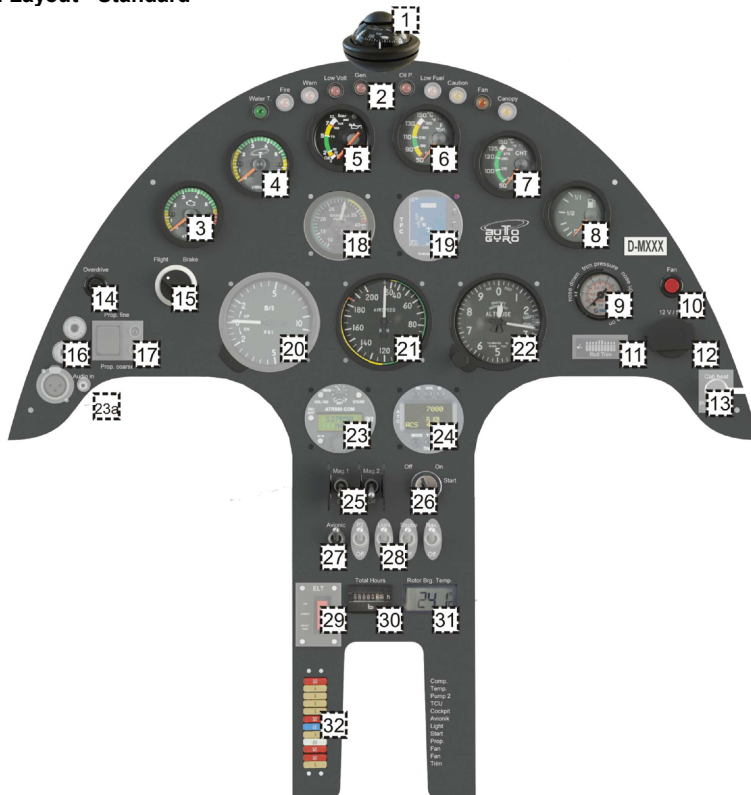

- |   |   |
|---|---|
| 1 – Magnetic compass  | 18 – Manifold pressure gauge (if inst.)               |
| 2 – Warning lights  | 19 – Collision Avoidance System (if inst.)            |
| 3 – Engine RPM  | 20 – Vertical speed indicator (if installed)          |
| 4 – Rotor RPM   | 21 – Air speed indicator                              |
| 5 – Oil pressure  | 22 – Altimeter  |
| 6 – Oil temperature   | 23 – Radio (if installed)                             |
| 7 – Cylinder head temperature   | 23a – Audio in (if installed)                         |
| 8 – Fuel level indicator  | 24 – ATC transponder (if installed)                   |
| 9 – Trim/brake pressure gauge   | 25 – MAG switches                                     |
| 10 – Cooling fan manual activation  | 26 – Master/starter switch                            |
| 11 – Lateral trim indicator (if installed)                                  | 27 – Avionics master switch                           |
| 12 – 12V power receptacle (if installed)                                    | 28 – Switches (2 <sup>nd</sup> fuel pump and options) |
| 13 – Cabin heat control (if installed)                                      | 29 – ELT control (if installed)                       |
| 14 – Overdrive push button  | 30 – Hour meter                                       |
| 15 – Pneumatic mode selector  | 31 – Rotor bearing temperature indication             |
| 16 – Intercom/headphone sockets   | 32 – Fuses  |
| 17 – VPP control and end position<br>detection IVO propeller (if installed) |   |

Panel Layout – Moving Map Landscape

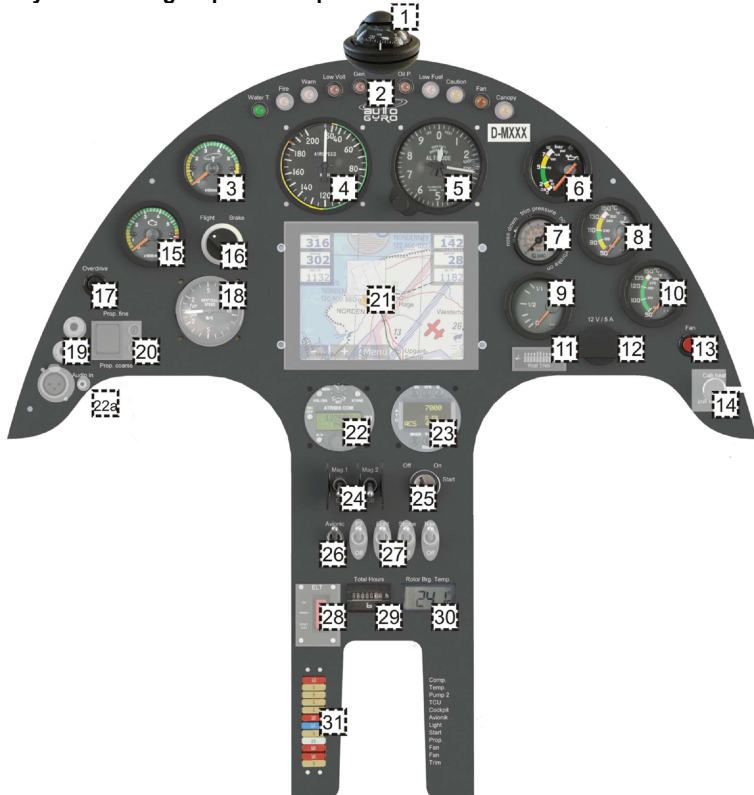

- |  |  |
|--|--|
| 1 – Magnetic compass                       | 18 – VSI 2 1/4" (47mm) (if installed)                                    |
| 2 – Warning lights                         | 19 – Intercom/headphone sockets  |
| 3 – Rotor RPM                              | 20 – VPP control and end position detection IVO propeller (if installed) |
| 4 – Air speed indicator                    | 21 – Installation provisions for MMS                                     |
| 5 – Altimeter                              | 22 – Radio (if installed)  |
| 6 – Oil pressure                           | 22a – Audio in (if installed)  |
| 7 – Trim/brake pressure gauge              | 23 – ATC transponder (if installed)                                      |
| 8 – Oil temperature                        | 24 – MAG switches  |
| 9 – Fuel level indicator                   | 25 – Master/starter switch   |
| 10 – Cylinder head temperature             | 26 – Avionics master switch  |
| 11 – Lateral trim indicator (if installed) | 27 – Switches (2 <sup>nd</sup> fuel pump and options)                    |
| 12 – 12V power receptacle (if installed)   | 28 – ELT control (if installed)  |
| 13 – Cooling fan manual activation         | 29 – Hour meter  |
| 14 – Cabin heat control (if installed)     | 30 – Rotor bearing temperature indication                                |
| 15 – Engine RPM                            | 31 – Fuses   |
| 16 – Pneumatic mode selector               |  |
| 17 – Overdrive push button                 |  |

Panel Layout – Moving Map Portrait (Garmin 695/795)

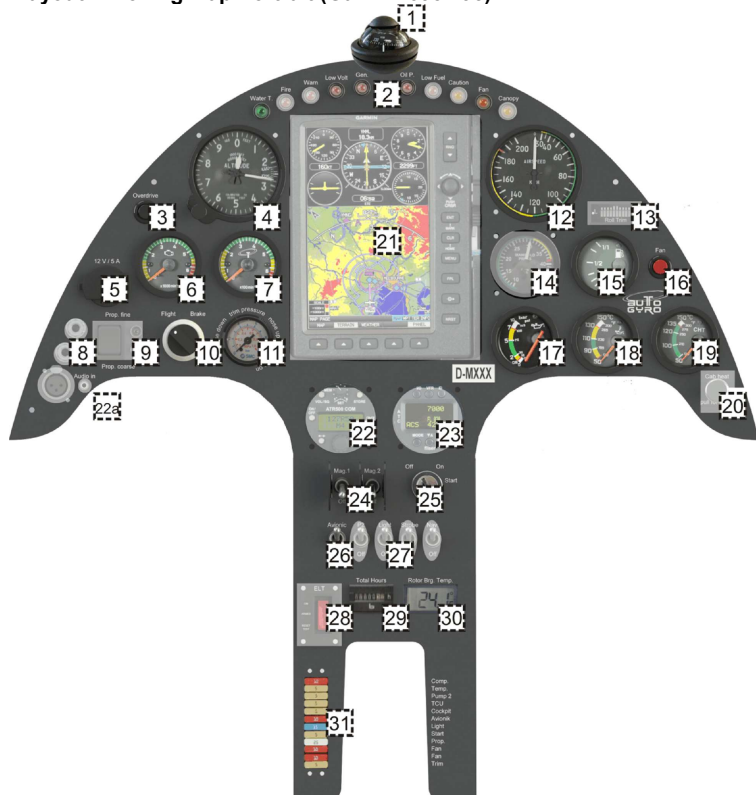

- |  |   |
|--|---|
| 1 – Magnetic compass   | 17 – Oil pressure                                     |
| 2 – Warning lights   | 18 – Oil temperature                                  |
| 3 – Overdrive push button  | 19 – Cylinder head temperature                        |
| 4 – Altimeter  | 20 – Cabin heat control (if installed)                |
| 5 – 12V power receptacle (if installed)                                    | 21 – MMS  |
| 6 – Engine RPM   | 22 – Radio (if installed)                             |
| 7 – Rotor RPM  | 22a – Audio in (if installed)                         |
| 8 – Intercom/headphone sockets   | 23 – ATC transponder (if installed)                   |
| 9 – VPP control and end position<br>detection IVO propeller (if installed) | 24 – MAG switches                                     |
| 10 – Pneumatic mode selector   | 25 – Master/starter switch                            |
| 11 – Trim/brake pressure gauge   | 26 – Avionics master switch                           |
| 12 – Air speed indicator   | 27 – Switches (2 <sup>nd</sup> fuel pump and options) |
| 13 – Lateral trim indicator (if installed)                                 | 28 – ELT control (if installed)                       |
| 14 – Manifold pressure gauge (if inst.)                                    | 29 – Hour meter                                       |
| 15 – Fuel level indicator  | 30 – Rotor bearing temperature indication             |
| 16 – Cooling fan manual activation   | 31 – Fuses  |

Panel Layout – Glass Cockpit (DYNON AVIONICS SkyView.)



- |   |   |
|---|---|
| 1 – Magnetic compass  | 13 – 12V power receptacle (if installed)              |
| 2 – Warning lights  | 14 – Cabin heat control (if installed)                |
| 3 – Lateral trim indicator (if installed)                               | 15 – Radio (if installed)                             |
| 4 – DYNON Integrated Display  | 15a – Audio in (if installed)                         |
| 4a – Integrated display warning light                                   | 16 – ATC transponder (if installed)                   |
| 5 – Back-up air speed indicator   | 17 – MAG switches                                     |
| 6 – Overdrive push button   | 18 – Master/starter switch                            |
| 7 – Intercom/headphone sockets  | 19 – Avionics master switch                           |
| 8 – VPP control and end position detection IVO propeller (if installed) | 20 – Switches (2 <sup>nd</sup> fuel pump and options) |
| 9 – Pneumatic mode selector   | 21 – ELT control (if installed)                       |
| 10 – Back-up altimeter  | 22 – Hour meter                                       |
| 11 – Cooling fan manual activation                                      | 23 – Rotor bearing temperature indication             |
| 12 – Trim/brake pressure gauge  | 24 – Fuses  |



Photographs of early instrument panels showing the warning lamps located centrally. Equipment function is the same as later generation panels.

#### Switch functions

Keyswitch. First stop supplies power to the instrument panel and equipment. Second stop will engage starter motor. An interlock prevents re engagement of the starter without cycling the switch to 'off' first.

Avionics. On supplies power to the radio, transponder and GPS (where fitted). Also the electronic ASI and Altimeter (where fitted)

Lights. On supplies power to the landing lights (where fitted)

Nav. On supplies power to the navigation lights (where fitted)

Strobes. On supplies power to the strobe lights (where fitted)

Mag switches. When off this earths the cable to the engine ignition coils, preventing engine start.

Fan button. With the keyswitch on, depressing this will start the engine cooling fan. The fan will run for a set period and then stop automatically. The fan motor draws 8A.

Change over switch (Brake to Flight). Changes the air supply to the trim/brake cylinder to either allow the rotor brake or the in-flight pitch trim to be applied.

Pre-rotator & rotor brake interlock release. Depressing this button with the rotor brake applied will allow the use of the pre rotator to drive the rotors to a centered position.



Note re Rotor bearing temp indicator. The purpose of this is to advise the pilot of an unusual rise in temperature of the bearing. In general use it may be used to indicate the outside air temperature in the region of the rotor head.

### 7.15 Intercom

The standard intercom system features standard headset sockets (TSR Tip Ring Sleeve) with additional optional XLR-3 socket for active headset power supply. Sockets are provided in each station, on the left hand side of the pilots respectively co-pilots seat. The intercom amplifier and VOX control is integrated in the respective radio.

In case of ATR 833, an audio in socket is provided in the instrument panel right beside the radio. Audio sources can be connected to the intercom system using a standard 3.5 mm audio jack.

See manufacturer's manual for additional information.

### 7.16 Pitot Static

Total pressure is picked up by a pitot tube located in the nose section of the fuselage. The tube is connected to the integrated cockpit instruments by a plastic line. The static pressure is measured across two ports, one on either side of the fuselage.

### 7.17 Indicators and Sensors

Rotor speed is measured by a magnetic pick-up, located directly at the geared ring of the rotor head. Rotor bearing temperature is measured by a temperature sensor which is glued into the rotor bearing sleeve.

If Rotorhead II is embodied then an additional indicator "Clutch" is provided. Comparison of rotor RPM with engine RPM governs the CLUTCH indication that informs the pilot about a slipping clutch (continuous light) or warns of an attempted take-off run with the risk of blade flapping (blinking).

- CLUTCH is on with engine speeds above 2200 RPM and rotor speed not matching while pre-rotator is depressed (slipping clutch)
- CLUTCH is blinking with engine speeds above 5000 RPM and rotor speed below 200 RPM (attempted take-off run with the risk of blade flapping)

#### NOTE

**If the stick is pulled back more than 5degrees the pre rotator clutch will automatically disengage. In this case the CLUTCH lamp will indicate a continuous light until the pre rotator button is released.**

Rotor bearing temperature is measured by a temperature sensor which is glued into the rotor bearing sleeve. This is deleted when rotorhead III is installed, and replaced by an OAT sensor located under the aircraft body rear of the nosewheel.

Other indicators and sensors have been described in the respective paragraphs. For engine related indicators and sensors see the engine manufacturer's manual.

### 7.18 Seats and Seatbelts

The seats consist of seating surface as an integral part of the monocoque structure and backrest, upholstered with removable cushions. The cushions consist of a foam core covered with an easily cleanable, water-repellent fabric.

The base cushions are optionally available with a Dynafoam filling. Dynafoam is used to give increased occupant protection.

The forward backrest hinges are positioned by 4 countersunk Allen bolts on two seating rails. To suit to different leg lengths the backrest hinges can be adjusted by removing the Allen bolts and refitting in a different position on the rails.



Hinge attachment screws

Take care to tighten securely, and to ensure both hinges are the same number of holes from the rearmost position.

In addition the backrest can be adjusted by modifying the lengths of the two adjustment straps. When adjusting make sure that full travel of the aft control stick is not restricted, if installed. The aft seat has no adjustment.

An adjustable four point harness is fitted for each seat. Make sure that the aft seat belt is buckled and tight when flying with the aft seat unoccupied.

### 7.19 Stowage Capacity

Two storage compartments are located below each seat with a maximum capacity of 2.5 kg each (2.0Kg UK).

### 7.20 Fire Warning System

The Calidus gyroplane may be equipped with a Fire indicator light to alert the pilot that a certain temperature in the engine compartment has been exceeded, possibly as a result of a fire. The fire indication circuit is based on a special cable routed inside the compartment(s). The cable has two integrated wires separated by an insulation layer. At a defined temperature the insulation layer will melt and the embedded wires close contact.

A possible fire (circuit closed with low resistance) will be indicated by a flashing/blinking Fire indicator light in the Warning and Caution Panel. During normal operation (circuit closed with 'normal' resistance) the Fire indicator light will be off. A malfunction of the system (circuit open or shorted to ground) is indicated by a constantly lit Fire indication. At every power-on event the system will perform a lamp test consisting of a series of three flashes.

Indicator Light	System Status
OFF	Normal Operation (normal resistance)
FLASHING	Fire, abnormal temperature (circuit closed)
ON	System Malfunction (circuit open or shorted to ground)

In the event of a fire indication being shown, proceed according to emergency procedure "Smoke and Fire" provided in SECTION 3.

### 7.21 Fuses

Fuse description	Rating	Protects	Fuse type	Location
Main incoming supply to cockpit	30A ETFE 40A PVC	Main positive supply is fed to the starter solenoid from the battery. The supply continues then through the 30amp fuse to the cabin.	Bolt in strip type, MTA S.p.A. "Midival" range	Engine bay fuse box, above left fuel tank, on rear face of enclosure or engine bearer.
Compressor	10A	Fuse only supplies the pneumatic compressor	Automotive	Inst. Panel
Primary Fuel pump (replaced by	5A	Fuel pump	Automotive	Inst. Panel



'GEN 1' in later models				
Secondary fuel pump	5A	Fuel pump	Automotive	Inst. Panel
914UL TCU	5A	Engine control unit	Automotive	Inst. Panel
GEN 1	5A	Primary Fuel pump relay, where fitted	Automotive	Inst. Panel
GEN 2	5A	Generator operation, where fitted	Automotive	Inst. Panel
Cockpit	5A	All electrical gauges (rotor and engine rpm, oil pressure, water and oil temps, fuel gauge) and warning lamps	Automotive	Inst. panel
Avionics	10A	Radio, Transponder and GPS units	Automotive	Inst. panel
Landing lights	15A	Strobes, landing lights, nav lights and aux socket. NOTE! Aux socket may be fitted with additional 5amp in line fuse.	Automotive	Inst. panel
Start	5A	Starter relay and SMD module	Automotive	Inst. panel
Variable pitch propeller (where fitted)	25A	Main supply IVO-prop variable pitch propeller	Automotive	Inst. panel
Fan	5A	Thermostat control of fan via relay	Automotive	Inst. panel
Fan	10A (15A permissible)	Power supply to fan via relay	Automotive	Inst. panel
Vent	5A	Cabin heater fan	Automotive	Inst. panel
Trim	5A	Supplies power to the stick controls for operating the pneumatic solenoid valves and the compressor relay	Automotive	Inst. panel
Rotax regulator	25A ETFE 30A PVC	Charging circuit from regulator to battery/aircraft supply	Automotive 25A fuse, located between the 30A fuse and the cockpit supply	Engine bay fuse box, above left fuel tank, on rear face of enclosure or engine bearer.

Starter	100A ETFE cable 125A PVC cable	Primary supply from battery to starter-solenoid /starter and from starter solenoid to main fuse	Midvale 80Amp fuse, published time at 80A, asymptotic, 13secs at 150A. Fuse mounted after the solenoid.	Engine bay fuse box, above left fuel tank, on rear face of enclosure or engine bearer.
External battery charge point (where fitted)	15A	Cable from short circuit when fitting or removing the cowls	Automotive glass fuse	Near battery
Flymap L (where fitted)	5A	GPS only	Automotive glass fuse	Power supply lead to GPS unit behind instr. panel
Garmin GPSmap (where fitted)	1.5A	GPS only	Automotive glass fuse	Power supply lead to GPS unit behind instr. panel
Avmap EKP IV (where fitted)	2A	GPS only	Automotive glass fuse	Power supply lead to GPS unit behind instr. panel

Reference to ETFE or PVC cable refers to the cable insulation material used in the wiring harness. Certified markets require the use of ETFE cable (generally Primary category USA and Permit Category UK).

Specific aircraft GPS fitments may have alternative fusing arrangements.



Primary Fuse box, cover off, normally located above the fuel tank or historically the upper engine bearer bracket, left side in the engine bay. Each fuse is marked with the rating for that fuse.

## 7.22 Cabin heater

The Calidus gyroplane may be equipped with an optional cabin heater system.

Two systems are available;

1. Warmed air intake from the coolant radiator. This simple system uses an extraction box mounted under the coolant radiator to route warmed air into the cabin via a stainless steel butterfly valve mounted above the rear seat occupants right shoulder. The valve is controlled via a push-pull cable mounted in the instrument panel. There is no adjustment available other than that for the valve being fully closed when the operating knob is pushed into the panel. This configuration is no longer manufactured.
2. Hot water heated air. This system utilises the engine coolant routed via PTFE lined braided hoses through the cabin to the pilots footwell. A radiator and fan is mounted inside the aircraft nose, through which the coolant runs. The fan pumps the warmed air into the footwell and area between the inside and outside body, venting along the body sides into the cabin.

The water flow rate is varied by operating the push/pull cable mounted on the instrument panel, which connects to a flow valve. The fan may be either turned on by the initial pull of the push/pull cable, or in later models, by activating the 'vent' switch.

Note that the fan is de-activated when the low volt lamp is on.

Additionally there is a small vent in front of the front stick, which is effective in demisting the screen interior.



INTENTIONALLY LEFT BLANK

## CONTENTS

8.1	Maintenance Obligations .....	8-1
8.2	General .....	8-1
8.3	Ground Handling .....	8-2
8.4	Cleaning .....	8-2
8.5	Refuelling .....	8-2
8.6	Checking of Engine Oil Level .....	8-3
8.7	Checking of Engine Coolant Level .....	8-3
8.8	Tire Pressure .....	8-3
8.9	Lubrication and Greasing .....	8-4
8.10	Replenishing of Fluids .....	8-4
8.10.1	Engine oil .....	8-5
8.10.2	Engine coolant .....	8-5
8.11	Engine Air Filter .....	8-5
8.12	Propeller .....	8-5
8.13	Battery .....	8-5
8.14	Winter Operation .....	8-6
8.15	Removal, Disassembly, Assembly and Installation of the Rotor .....	8-7
8.15.1	Removal of the Rotor System .....	8-7
8.15.2	Disassembly of the Rotor System .....	8-9
8.15.3	Assembly of the Rotor System .....	8-10
8.15.4	Installation of the Rotor System .....	8-11
8.16	Road Transport .....	8-11
8.17	Repairs .....	8-12





INTENTIONALLY LEFT BLANK

## SECTION 8 - HANDLING AND SERVICING

This chapter contains guidelines for correct handling and servicing of the gyroplane, as well as manufacturer recommendations helping to keep its performance, reliability and value.

### 8.1 Maintenance Obligations

The owner/operator is responsible to ensure that the aircraft is kept in an airworthy condition. With respect to continuing airworthiness, manufacturer requirements and regulations from your competent aviation administration (for example annual airworthiness inspection) need to be complied with.

All airworthiness limitations, inspections and time limits are described in detail in the maintenance manual. However, for owner/operator's information the intervals for mandatory maintenance events are provided as follows:

- 25 hrs: "25 hrs inspection" (one-time / non-recurrent)
- 100 hrs / 12 months (whatever occurs first): "100 hrs inspection"
- 1500 hrs / 5 yrs: "Supplemental inspection"

For engine maintenance and overhaul, refer to the engine manufacturer's manual.

Special inspections have to be performed by an authorized and qualified maintenance centre or the manufacturer after operational incidents, which are

- Suspected hard landing
- Rotor contact with obstacle
- Propeller contact with obstacle or external impact
- Bird strike
- Lightning strike

If any of the above cases apply, mark the aircraft as 'unserviceable' and consult the manufacturer or an authorized maintenance and repair station before further operation.

Apart from these obligatory inspections and maintenance tasks, the owner/operator is entitled to perform the following preventive and in-between maintenance tasks and checks, as well as exchange of parts and minor repairs:

### 8.2 General

Whenever possible, park the gyroplane in a place where it is protected from direct sunlight, wind and humidity. High humidity, especially in combination with a salt-laden atmosphere will lead to corrosion and/or composite structure paint blisters. The sunlight's ultra-violet radiation and the heat impact on the GRP/CRP components may lead to a degradation of the materials integrity. The manufacturer will take no responsibility for damage or impaired safety margin due to improper treatment.

### 8.3 Ground Handling

Experience shows that aircraft may be exposed to much higher loads when operated on ground, than when in flight.

Take care not to impose high loads caused by excessive and fast taxiing on rough terrain, or hard bouncing of the aircraft over the hangar thresholds etc.

Use caution when handling the gyroplane on ground. Do not push hard at the rudder or at the outer stabilizers. Avoid excessive swing of the rotor blades as repeated bending ultimately leads to fatigue or damage.

### 8.4 Cleaning

Care and regular cleaning of engine, propeller, rotor system and fuselage is the basic foundation for airworthiness and reliability. Therefore, the gyroplane should be cleaned after every last flight of the day or more often, if environmental conditions dictate.

In order to protect the gyroplane against dirt, dust, bird soil, and sunlight, the aircraft should be covered with the Autogyro covers or a light plastic tarpaulin or cloth (use a clean, lint free, cloth for the canopy). Openings to the engine, service access port and airspeed indicator should be closed after the flight (to limit access for insects, birds etc.).

Contamination can be cleaned with clean water, possibly with mild cleaning additives. To clean the rotor it is best to soak contamination with a cloth or towel, wipe with soft or micro-fibre cloth, and rinse thoroughly with water.

A clean canopy aids safe flying. Clean with fresh water for removal of grit etc, without rubbing the grit into the canopy surface. Then use proper plexiglass cleaning sprays such as Plexus with soft lint free cloths to polish and finish the surface inside and out. Read and follow the product instructions.

A good quality polish helps protect the surface finish and reduce surface friction.

Use of RainX or other proprietary rain repellent compound will help rain drops wash away when flying in rain. Read the instructions, and ensure the compound is suitable for use on Plexiglass. It is recommended to check that it does not affect the canopy by applying to a small rearwards area first and checking for any negative reaction.

#### CAUTION

**Do not use gasoline or solvents as cleaning agents for the windshields, as they may destroy them irreparably. Do not let windshields sun-dry after washing as they will stain permanently.**

### 8.5 Refuelling

Have aircraft electrically grounded before refuelling by attaching the earth (ground) lead to the engine exhaust pipe. Be aware that most airfield refuelling equipment is laid out for larger diameter tank filler necks and high flow rates. To avoid contamination, use a funnel with strainer and/or filter when refuelling from canisters. In order to top-off tanks it is recommended to fill-up slowly and to allow flow levels to balance-out as the cross-over flow rate is limited.

Use the fuel drain/water check point to check for water after refuelling.

**NOTE**

**Do not fill to the absolute maximum in order to allow for thermal expansion of the fuel.**

### 8.6 Checking of Engine Oil Level

Before attempting to check the engine oil level double check that both Magnetos are switched off. The oil level is measured with the aircraft in a level attitude and should be between the marks on the dipstick.

Open oil tank access cover, remove oil reservoir cap and dipstick. Turn the engine by the propeller in the correct sense of rotation until you clearly hear the oil gurgle in the tank over several rotations.

Insert cleaned dipstick for measurement. Fill up oil according to the engine manufacturer's specification when required. After completion make sure the dip stick is in place and the reservoir cap is back on securely. Install access cover.

**CAUTION**

**Never attempt to turn the engine against its sense of rotation as this may lead to expensive hydraulic tappet damage.**

### 8.7 Checking of Engine Coolant Level

Between flights, the engine coolant level is checked by verifying the level in the overflow bottle is within min. and max. markings. The coolant level can be easily seen when looking at the transparent overflow bottle when the access cover is removed.

For additional details concerning this pre-flight check and a description of the more comprehensive daily check procedure, refer to the engine manufacturer's manual.

### 8.8 Tire Pressure

Main wheels .....	1.8 – 2.2 bar
(if operating at 560kg take-off weight increase to 2.3 bar)	
Nose wheel .....	1.6 – 2.0 bar
(if operating at 560kg take-off weight increase to 2.2 bar)	

Tyres fitted with green valve caps have been filled with nitrogen.

The mainwheels are fitted with tyre size 400/100-2Ply (with inner tube, approx. 1Kg ea) or the heavier duty Sava 4.00-8C B13 71J 6PR TT tyres (approx. 1.6Kg ea) for operation at 560Kg MTOW.

Use of Heidenau 4.00-8 55M tyres (2Kg ea) is also permissible.

The nose wheel is fitted with tyre size 400-4, or the heavier duty Tost Aero 400-8 (especially required for 560Kg MTOW operation).

If flying in the winter with a frozen-over or snow covered runway, it is advisable to remove the wheel spats in order to avoid their damage and snow build up inside them. It is the pilot's responsibility to ensure that in the rear part of the spat no snow has built up, which could lead to freezing against the wheels and stopping them from turning. When refitting wheel spats, always use Loctite 243 on wheel spat fastenings,

**CAUTION**

**Operation of the aircraft on very slippery surfaces requires great care – the aircraft may slide sideways during pre-rotation, take off, or in ordinary ground handling, resulting in high potential for an accident. Use care!**

### 8.9 Lubrication and Greasing

Between maintenance intervals the owner/operator is entitled to do the following lubrication and greasing:

Component	Interval	Application	Type
Teeter hinge	5 hrs (recomm.)	as required	AutoGyro S.VB6007, 88-00-00-S-30477 or equivalent
Pre-rotator drive coupling sleeves	as required	as required	AutoGyro S.VB6006, 88-00-00-S-30476

**CAUTION**

**Rotor vibration is often caused by looseness of the teeter bolt in the rotor or teeter tower bushes, in turn caused by insufficient greasing of the rotor grease nipple. Regular greasing reduces wear.**

**CAUTION**

**While lubricating teeter hinge (especially with new bush bearings and related close gap dimensions) it may be possible that only very small amounts of lubricant pass through the grease nipples on the rotor. In this case, do not press too hard but better remove the bolt, lubricate the outside and re-install. Use a new split pin!**

### 8.10 Replenishing of Fluids

### 8.10.1 Engine oil

See engine manufacturer's manual.

### 8.10.2 Engine coolant

50/50 mix of Ethylene Glycol and distilled water, as per the engine manufacturer's manual. The upper engine cowling must be removed for access!

### 8.11 Engine Air Filter

The air intake filters need to be replaced or cleaned according to the manufacturer's recommendation. Depending on environmental conditions, such as dust, sand, or pollution the recommended rate of maintenance should be increased as required. Engine cowling must be removed!

### 8.12 Propeller

Clean regularly as contamination will noticeably decrease its efficiency, resulting in a negative effect on both aircraft performance and noise emission. Use either pure water or add mild cleaning additives. Let contamination soak, then remove with a soft cloth or micro fibre material and rinse thoroughly with water. Check for erosion and damage, especially at the leading edge and blade tips. Check tight fit at the propeller blade root or any unusual sound when tapping the blades, especially in the case of a variable pitch propeller. If in doubt or if damage is obvious, consult the aircraft manufacturer or a qualified maintenance station. Minor chips may be repaired. Consult the AMM for detail.

#### NOTE

**Flight in rain will result in increased wear to the propeller leading edge. If prolonged operation in rain is required, fitment of a suitable thin propeller tape to the leading edge will reduce wear.**

**Note that propeller tape will reduce propeller efficiency and aircraft performance dependent on the thickness and application. It is the operator's responsibility to understand and plan for this!**

### 8.13 Battery

The aircraft is fitted with a maintenance-free gel electrolyte battery. Maintenance is therefore limited to outside soundness, correct attachment, and cleaning. Check integrity of the battery as leaking fluid contains corrosive sulphuric acid which would lead to extensive damage when contacting the framework and attachments.

Charge the battery only with a charging device which is suitable for gel electrolyte batteries.

#### CAUTION

**The battery must never be deep discharged, as it will be damaged. If so, it might need to be replaced.**

### 8.14 Winter Operation

The cooling system for the cylinder heads of the engine is filled with a mixture of ethylene glycol anti-freeze and water, which gives freezing protection down to -20°C. Check protection temperature of the coolant and add anti-freeze, if necessary.

If temperatures are expected to fall below protection temperature, drain the coolant, and if required for service, refill with pure antifreeze. As anti-freeze ages, renew the coolant every two years. Read the engine manual for the manufacturer's recommendations.

#### CAUTION

**Pure antifreeze is not as good an engine coolant as a 50/50 mix with water. Take care that engine coolant limits are not exceeded. As soon as ambient temperatures permit, drain and refill with the normal coolant mix.**

During winter operations the necessary operating temperature for oil and cooling agent may not be reached. This can be compensated by taping some portion of the coolers. Monitor all engine temperatures closely after having the coolers taped and modify as required.

If installed, it is recommended for preventing icing to the carburettor to remove the air filter tube, which leads the air filter out of the engine cowlings, at sustained environmental outside air temperatures (OAT) below 10 °C. The air filter should be mounted to the engine directly. In this case the opening for the air filter in the engine cowling should be sealed with proper duct tape.

Before each flight inspect all control cables for free and easy movement and sufficient lubrication.

## 8.15 Removal, Disassembly, Assembly and Installation of the Rotor

In order to transport or park the gyroplane with minimum space requirements, the rotor system can be removed and disassembled, if needed. In order to do so, a second person is needed to assist and help to prevent any damage to the gyroplane or the rotor system.

### WARNING

The rotor system and rotor head construction must be correctly matched. Incorrect matching can result in excessive or too little teeter movement, endangering the aircraft!

Rotorsystem 1 has a solid square teeter block fitted to the top of the rotor. Wt approx. 28Kg

Rotorsystem II has a tall scalloped teeter block. Wt approx. 31Kg (red end cap), or 35Kg (blue end cap).

Rotorsystem II for rotorhead III has a short scalloped teeter block.

The nominal teeter angle is +/-7deg!

### WARNING

The rotor system must be removed and disassembled for road transport. When handled incorrectly the rotor system can be damaged irreparably. If undetected this may have catastrophic consequences.

### CAUTION

When removing or disassembling make sure to mark all parts so that each and every component of the rotor system is reassembled and installed in exactly the same way and orientation. Some rotor blades have loose washers in them which are required as balance weights. Do not remove or restrain if present!

### NOTE

Rotorsystem II is shown in the photos and text.

Rotorsystem I construction is the same, excepting that the hub bar is not scalloped, and all the blade to hub bar bolts are the same length.

### 8.15.1 Removal of the Rotor System

1. Secure the gyroplane on level ground by engaging the parking brake, adjust the rotor system lengthwise and pump up the rotor brake to its maximum.
2. Set the propeller such that one blade is pointing up on the aircraft centre line.



3. Remove and discard split pin and unscrew the castellated nut (5). The rotor system has to be tilted onto the black rotor teeter stop.
4. The teeter bolt (1) has to be extracted by using only the hand, not a hammer. If needed tilt the rotor blades carefully onto the teeter stop, in order to prevent the bolt from jamming. Make sure that the rotor stays level in the teeter axis, if not the teeter bolt will damage the Teflon coated bushes, while being pushed out.
5. A supervised second person has to hold the rotor system in flying direction.
6. Lift the rotor system carefully out of the teeter tower and be aware of the position of the shim washers (2). Their thicknesses may differ and it is essential that they are reinstalled on the correct side! They are marked with dots to identify the correct side.
7. Remove the rotor system to one side by letting it rest on your shoulder and take care not to collide with stabilizer or propeller.
8. The shim washers and the teeter block in the hub are marked on each side with one or two engraved dots. Directly after the disassembly the shim washers need to be fixed on their respective side with cable ties to prevent loss.
9. The rotor system must not be placed on a dirty or grainy surface, as the blades can scratch and damage easily. The best way is to place the rotor blades centrally onto two stands, supporting the rotor at approximately 2 m distance from the hub.

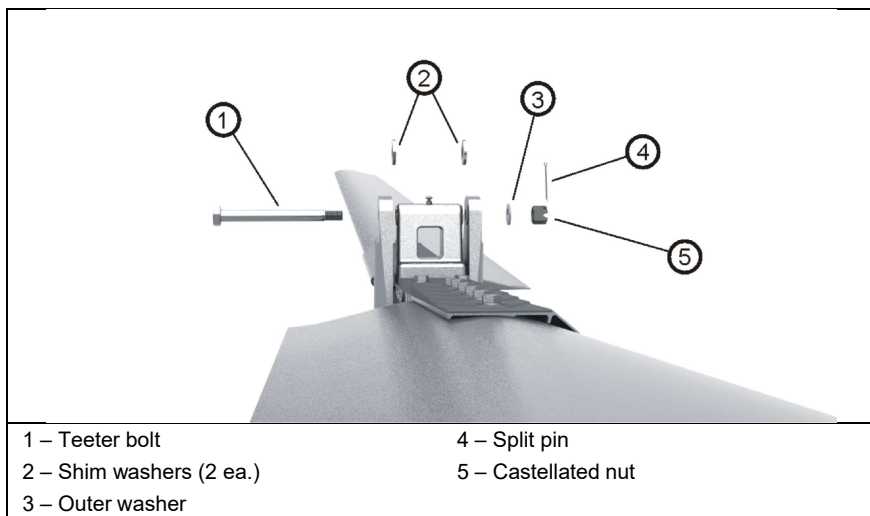

### Handling of the Rotor System

Do not lift or support the rotor system at its blade tips as the bending moment due to the weight of the hub assembly may overstress the blade roots. If possible, handle with two persons while holding approximately in the middle of each blade. When supporting the system use two stands each positioned in about 2 metres distance from the hub.

**CAUTION**

The assembled rotor system can be damaged irreparably if handled incorrectly. If the rotor system is lifted in a wrong way, its own weight may overstrain the material.

**8.15.2 Disassembly of the Rotor System**

1. To disassemble the rotor system, place it upside down onto a clean surface or stands to support the rotor at approximately 2 m from the hub (so that the system is at the design coning angle of 2.4deg per side).
2. Loosen locknuts (6) on the first blade by counter holding the corresponding bolt head to prevent it from turning inside the blade holes.
3. Push out all fitting bolts (4) without any force, but use no more than a gentle tapping if necessary. Tilt the rotor blade up and down to support easy removal of the bolt.
4. Carefully pull the rotor blade out of the hub (1) in radial direction and take off the clamping profile (2).
5. Repeat step 2 to 4 on second rotor blade.
6. **Do not disassemble the rotor hub!**
7. Store and transport rotor blades, clamping profile and rotor hub only in air cushion foil or using other suitable means to prevent bending or surface damage.

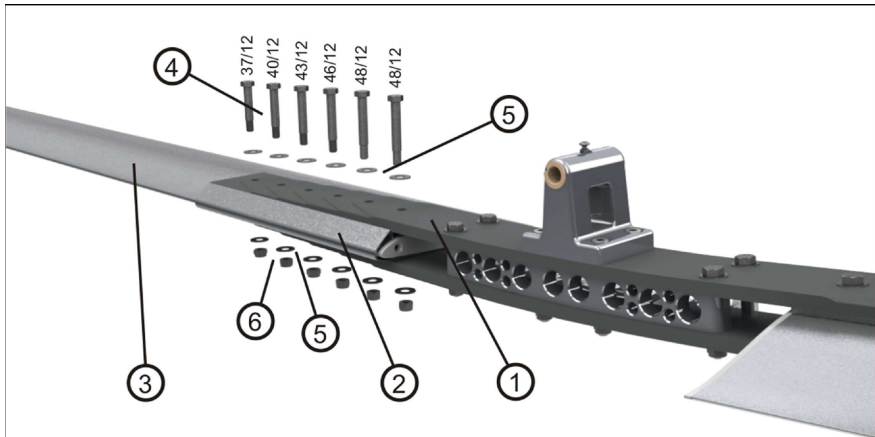

- |                      |                           |
|----------------------|---------------------------|
| 1 – Rotor hub        | 4 – Fitting bolts (6 ea.) |
| 2 – Clamping profile | 5 – Washer (12 ea.)       |
| 3 – Rotor blade      | 6 – Lock nuts (6 ea.)     |

**NOTE**

The nuts retaining the teeter bolt to the hub bar should be of the BinX type, in order to maximise the clearance to the teeter stop plate.

**8.15.3 Assembly of the Rotor System**

1. The rotor blades, clamping profile and rotor hub are labelled with an engraved serial number.
2. Insert the first rotor blade carefully into the clamping profile. Make sure that all serial numbers match.
3. Fit the rotor hub side with the according serial number to clamping profile and blade. Insert fitting bolts without using force so that the bolt end is on top when the rotor system is installed. For re-identification and correct installation position the shaft length is provided in the figure above. Example: 40/12 means shaft length 40mm.
4. Position the washers and the locknut and hand-tighten all nuts to close the joints.
5. Position the rotor onto two trestles, 4m apart. This will allow the rotors to sit at the correct coning angle. A shortened trestle (approx. 80mm shorter) located under the hub bar will set the angle correct for easy fitment of the second blade.
6. Repeat steps 2 to 5 for the second rotor blade, such that the rotor sits on the trestles with the hub midway between the trestles.
7. Attach a taut thin line, such as fishing line, between the blade tips, in the same position at each tip. Slipping the line between the end cap tail and the blade enables accurate positioning.
8. Remove the centre trestle, and raise the centre of the hub bar. Watch to see where the line is with respect to the grease nipple. Adjust the blade position in the hub assembly within the bolt freeplay to move the line as close as possible to run directly over the grease nipple.
9. Torque-tighten nuts with 15 -25Nm from the inside to the outside, using a torque wrench. When doing so, counter-hold bolts to prevent any damage the hub and blade holes.

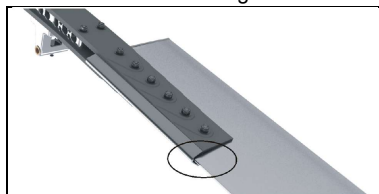

Position where serial numbers are engraved (bottom side)

**WARNING**

It is important to fit the correct length bolt in the associated hole! Fitting the wrong length bolt may result in insufficient safety protrusion through the nylock nut, or that the nut jams on the shank of the bolt before the joint is properly tightened.

### 8.15.4 Installation of the Rotor System

#### CAUTION

**During installation make sure to have each and every part of the rotor system installed in exactly the same way and orientation as it was before.**

1. Secure the gyroplane on level ground by engaging parking brake, adjust the rotor head or teeter tower corresponding to fore-aft and pressurize the rotor brake up to maximum.
2. Check correct matching of parts: The rotor hub and the teeter tower are marked with two dots according to the orientation for installation.
3. Lift the rotor blade with a second briefed person (one person standing aft, one person standing directly in front of the hub).
4. Approach with the rotor system from the side to the gyroplane and make sure not to collide with propeller or stabilizer. Insert the rotor system into the hub from above while standing on a ladder or the rear seat.
5. The second person can let go, as soon as it is resting centrally in the teeter tower on the teeter stops.
6. Insert teeter bolt by hand in the same orientation as it was before (bolt head should be at that side of the teeter block which is marked with one dot) while matching the shim washers with the corresponding installation positions.
7. Check direction of assembly and shim washers: rotor hub, teeter tower and shim washers are marked on each side either with one or two engraved dots.
8. If the teeter bolt cannot be inserted, tilt the rotor blade along the teeter axis with the free hand.
9. Install washer and castellated nut. Hand-tighten only, 1-2Nm, and secure with a new split pin. Use split pins only once. Make sure that the teeter bolt can be turned easily by hand.
10. Check that the rotor teeters freely to the teeter stops, and grease the hub block grease nipple. Fit tie down bag to secure the rotor.

### 8.16 Road Transport

If road transport cannot be avoided, transport with minimum fuel, which reduces airframe loads and prevents fuel spilling through vent pipes.

Switch ELT (if installed) off for road transport to avoid false alarms!

Tie-down the fuselage using the following procedure:

- Restrain main wheels (blocks/chocks)
- Put a wooden block below the lowest point of the keel tube and lash keel tube against wooden block. The block should be dimensioned so that the main wheels are half way unloaded
- Lash down both main wheels through the lashing lugs (use rims/axles alternatively)
- Lash down nose wheel through the axle
- For container transport or shipping, use the mast tie-down kit (option)

Furthermore, it is recommended to protect the gyroplane against external exposure – eg salt in the winter, grit etc. The rotor blades must be packed carefully, as even the smallest damages may force the replacement of the complete system.

**WARNING**

**The rotor system must be removed and disassembled for road transport. When handled incorrectly the rotor system can be damaged irreparably. If undetected this may have catastrophic consequences.**

**CAUTION**

**When wrapping make sure that the foil or stretch wrap does not directly cover painted surfaces. Put a soft layer in between for damage protection and let plastic components breathe. Do not expose wrapped gyroplane or parts to sun radiation or heat in order to avoid paint damage.**

## 8.17 Repairs

**IMPORTANT NOTE**

**Repairs may only be executed by Authorised Persons, and in strict compliance with the AMM and any issued repair instructions.**

## SECTION 9 - SUPPLEMENTS

### LIST OF SUPPLEMENTS

- 9-1 Variable Pitch Propeller - IVO
- 9-2 Lights
- 9-3 GPS/Moving Map Systems
- 9-4 Fire Indication
- 9-5 Canopy Indication
- 9-6 Stowage Compartment
- 9-7 ELT (Emergency Locator Transmitter)
- 9-8 Removal/Installation Canopy

INTENTIONALLY LEFT BLANK

## 9-1 Variable Pitch Propeller - IVO

### 9-1.1 General

A variable pitch propeller (VPP) manufactured by IVO is available as optional equipment to optimize the propeller efficiency, fuel consumption, and noise in all flight regimes and power settings. This is achieved by changing the propeller blade pitch.

### 9-1.2 Limitations

No change to standard aircraft

### 9-1.3 Emergency Procedures

Proceed according to generic variable pitch propeller procedure provided in SECTION 3 for the standard aircraft.

### 9-1.4 Normal Procedures

#### 9-1.4.1 Set Propeller to FINE

In order to set the propeller to FINE for start-up, take-off and approach, use the following procedure:

- Press rocker in direction FINE (forward or top position), status indicator FINE flashes, engine RPM increases
- Keep rocker depressed until end position is reached (status indicator FINE steady on)

#### 9-1.4.2 Adjust Propeller COARSE

- Adjust propeller pitch and throttle to match engine RPM and manifold pressure according to the power setting table (9-1.5)

#### CAUTION

When adjusting the propeller do not overtorque (i.e. too high MAP for given RPM) the engine as this may lead to overloading, reduced life time or possible damage.

#### NOTE

As a safety measure, the mechanical end stop in full COARSE position is chosen to allow a residual climb rate of 1 m/s (250fpm) in standard atmospheric conditions at sea level with maximum take-off weight.



## PRE-FLIGHT INSPECTION

### Visual:

Check each of the propeller blades for damage, small nicks or delamination of the stainless-steel edge protector, and security of attachment to hub.

Check the aluminium hub parts for cracks or damage and security of attachment to engine

Check the security of the spinner and presence of 9-off attachment screws

Check the fabricated bracket holding the brush carrier for security of attachment and absence of cracks

Check the condition of the two carbon brushes (no pieces broken-off) and security of attachment screws.

## NORMAL OPERATION

### Engine start

Before starting the engine turn on the master switch and using the rocker switch select the full-FINE setting. (However, it is likely to be still fine from the previous inspection).

### Run-up and power checks

For the engine run-up, the propeller pitch should be kept full-FINE.

Make sure the brakes are applied!

### Take-off

For take-off, keep the propeller at full-FINE.

Monitor the engine RPM to ensure that the high RPM time limit specified by Rotax is not exceeded.

It is the pilot's responsibility to ensure that the recommended time limit is not exceeded.

### Cruise

When the aircraft, in the climb phase, reaches the required cruising level, level-out and adjust the throttle to the desired power level/manifold pressure. Then select the COARSE pitch setting required.

### Climb

To enter a climb while cruising in at any COARSE setting, the following sequence of actions should be carried out:

1. Raise the nose to start the climb
2. As the airspeed reduces progressively open the throttle to the desired setting
3. If the climb rate is not sufficient (e.g. below 400fpm) select the full-FINE pitch setting
4. Before levelling-out or initiating descent consider the manifold pressure/engine RPM and re-select COARSE when required

Caution: flying at low airspeeds with the propeller set fully coarse means that there may be little ram-airflow through the propeller, increasing the chance of engine stall at low or idle rpm. If the engine does stall set the propeller to full-FINE before re-starting.

### Descent

When descending, reduce the throttle as normal and when necessary, change the propeller pitch to full-FINE. (For example, when descending from the overhead to circuit height).

### Approach

Keep full-FINE selected when landing to be ready for a possible go around.

Engine shutdown

The engine should be in full-FINE for shutdown.

#### 9-1.4.3 Functional Check VPP

#### NOTE

**Functional check of the variable pitch propeller must be executed during engine run-up (see 4.7)**

Engine RPM: 4000 – Adjust variable pitch propeller in direction 'COARSE' until engine RPM decreases significantly. Afterwards adjust back into 'FINE' end position (status indicator FINE steady on); RPM must increase again up to 4000.

#### CAUTION

**Respect power plant limitations and instrument markings (see 2.6) during functional check – monitor MAP gauge!**

### 9-1.5 Performance

#### ROTAX 912 ULS

Power setting	Engine RPM	MAP	Fuel flow [ltr/h]
Max. TOP	5800	27.5	27
Max. MCP	5500	27	26
75% MCP	5000	26	20
65% MCP	4800	26	18
55% MCP	4300	24	14

#### ROTAX 914 UL

Power setting	Engine RPM	MAP	Fuel flow [ltr/h]
Max. TOP	5800	39	33
Max. MCP	5500	35	26
75% MCP	5000	31	20
65% MCP	4800	29	17.5
55% MCP	4300	28	12.5

MAP limits do not apply at engine speeds above 5100 RPM, marked by a yellow triangle at the RPM gauge / engine speed indicator.

**NOTE**

**Above data is valid for standard conditions at sea level. Keep in mind that engine and propeller performance is affected by altitude and temperature. For detailed information refer to the engine manufacturer's and propeller manufacturer's documentation.**

### 9-1.6 Weight and Balance

No change to standard aircraft

### 9-1.7 System Description

The IVO variable pitch propeller is controlled by a spring-loaded rocker switch labelled FINE and COARSE. Propeller pitch adjustment is controlled by an electronic circuit which provides system status indication using two status indicators (orange LED). Status indication logic and corresponding system status is described in the following table:

Status Indicators (orange)	System Status Propeller Pitch Control
Both LEDs off	No pitch change
Upper LED flashing	Propeller changing pitch to FINE
Upper LED steady on*	End position FINE reached and electronic pitch change inhibit FINE activated. LED goes out after 3 seconds (beginning with version 1.2)
Lower LED flashing	Propeller changing pitch to COARSE
Lower LED steady on*	End position COARSE reached and electronic pitch change inhibit COARSE activated LED goes out after 3 seconds (beginning with version 1.2)
Both LEDs flashing fast synchronously**	Actuating motor does not work despite rocker switch activation. Possible defects: brushes worn out, cable break, motor defect ...
Both LEDs flashing fast asynchronously**	An error occurred at least three times. Operation is not affected (beginning with version 1.3)

\*) To preserve the rubber stops motor drives in opposite direction for a short time when end positions are reached (back drive). The system knows the end positions already when starting the gyroplane (beginning with software version 1.1. Current version is v1.5, incorporating soft-start software).

\*\*\*) Indication can only be reset by switching the master switch temporarily to OFF and then back ON. In order to avoid pilot distraction, indication of a possible defect is re-triggered after another activation of the rocker switch.

Activation of the rocker switch closes an electrical circuit which energizes the electrical pitch control motor inside the propeller hub through brushes running on a slip (collector) ring. The electrical motor drives a mechanical gear which is connected to torsion tubes running inside the propeller blades. The blade pitch change motion is achieved by twisting the complete blade.

### **CONTROL**

No constant speed controller is fitted in this application and the pilot must select the appropriate power setting/manifold absolute pressure for the chosen propeller pitch.

### **PITCH LIMITS**

The propeller has two internal pitch limit stops, mechanically limiting the pitch angle at the pre-determined FINE and COARSE limits. These are different for 912ULS and 914UL engine applications.

**However, it is the pilot's responsibility to monitor engine rpm in the cruise and descent to ensure rpms are kept within operational limits!**

Note that the propeller requires up to 10secs to transit from full fine to full coarse pitch

### **CIRCUIT PROTECTION**

The propeller runs via an independent 25A fuse. Further, the propeller is controlled via a control unit that limits (under software rev1.5) the current drawn by the motor, and incorporates soft-start technology.

### **COPING WITH MALFUNCTIONS**

#### **Coping with control malfunction**

Care must be taken to set an appropriate rpm for the flight conditions, and if at fine pitch, do not descend at more than 80mph to prevent engine overspeed.

#### **Coping with a propeller pitch fluctuation malfunction**

If a malfunction causes the propeller pitch to fluctuate, remove the 25A fuse from the instrument panel. This will cease power supply to the propeller, causing it to stop in whatever position the supply stopped. Continue safe flight, ensuring there is no engine overspeed, and land when safe to do so. Investigate and rectify.

#### **Coping with propeller malfunction.**

A propeller may malfunction giving the following scenarios:



1. Propeller runs to fully coarse and stops. (RPM will decrease and MAP will rise. Reduce power if needed, to stay within MAP limits)

Continue flight with careful monitoring or if in any doubt make a precautionary landing.

**WARNING!**

- The climb rate will be reduced to 250fpm minimum!
- At fully coarse, the engine will be sustaining increased load at low rpm. Take care as if power is set to idle, it could result in an engine stall.

2. Propeller runs to fully fine and stops. (RPM will increase and propeller pitch will stop in full FINE position. Reduce power if needed, to stay within RPM limits).

Continue flight with careful monitoring or if in any doubt make a precautionary landing. Note that fully fine could result in engine speed over-run if taken to max power in level or descending flight! Set engine 5000rpm maximum at 80mph.

3. Propeller will not make pitch change (determined by no audible effect from engine when at constant power setting). Probable cause: failed propeller mechanism, end-position controller or cable fault. Follow the appropriate actions in 1. or 2. above and consider the further scenarios in the table below:

Before take-off	Do not take-off
During take-off and climb	Try to keep climbing to a safe altitude, return to the airfield and land. If the aircraft does not climb, maintain altitude and plan to return in a flat curve.
During cruise flight	Depending on the prop position, it should be possible to find a speed and RPM to continue the flight to the next possible landing area. Depending on the prop position your descent will look different and a go around is probably not possible.
During descent	Depending on the prop position (in case of coarse pitch), your descent will look different and a go around will probably not be possible.
During Landing	Continue approach as planned. If the prop changes to coarse pitch and the landing looks too long, keep in mind to cut the engine.

4. A propeller blade pitch becomes different to the others. Probable cause, internal mechanical failure. This will result in significant warning vibration. Reduce power and assess vibration with consideration of a precautionary landing. If necessary turn off engine & make immediate precautionary landing.
5. Loss of blade. This will result in severe vibration. Switch engine off and land immediately.
6. Loss of blade tip. This will result in significant vibration. Switch engine off and land immediately.
7. Loss of complete unit. This could result in destruction of the tail or other structural damage. Switch engine off and land immediately.
8. Loss of LED indicator lamps. Probable cause; controller failure or fuse blown (25A). Maintain aircraft speed and propeller pitch at around 80mph to prevent engine over-speed.
9. 25amp panel fuse blows. Loss of power supply to propeller controller, hence propeller. No pitch change possible, prop will remain at last pitch setting. Make precautionary landing if unsafe to continue the flight.
10. General Note – an increase in vibration from the engine area should always be investigated at the earliest opportunity. Typical causes are (but not limited to): loose engine mounting bolts to airframe or to the engine bearer, loose propeller, incorrect pitch setting (blade to blade, as set or from jamming), or blade damage. After the instance of such vibration the engine and airframe should undergo a detailed examination for subsequent damage. Refer to RSUK for guidance.

### 9-1.8 Handling and Servicing

Refer to the manufacturer's documentation, and where applicable RSUK0325 IVO DL3-68 Maintenance Manual.

#### CAUTION

**The propeller is electrically actuated via slip rings and carbon brushes. Surface corrosion and contaminants will prevent proper electrical connection and hamper correct operation. Always keep the slip rings clean!**

## 9-2 Lights

### 9-2.1 General

Depending on customer's configuration the gyroplane can be equipped with optional

- Landing lights
- Navigation /position lights
- Strobe lights
- Underbody landing light
- Instrument panel lighting

### 9-2.2 Limitations

No change to standard aircraft

### 9-2.3 Emergency Procedures

No change to standard aircraft

### 9-2.4 Normal Procedures

The lights can be switched on or off by respective switches in the centre panel, labelled

- "Light" for landing light
- "Nav" for navigation/position lights
- "Strobe" for strobe lights
- 'Panel' for panel lights

Due to their small silhouette gyroplanes are easily overlooked, especially if approached directly from behind, such as on approach. It is therefore highly recommended that navigation and strobe lights are switched on during flight.

### 9-2.5 Performance

No change to standard aircraft

### 9-2.6 Weight and Balance

No change to standard aircraft

### 9-2.7 System Description

Navigation and strobe lights are installed as combined units at the left hand and right hand side of the fuselage, behind the passenger station. The landing light consists of a pair of lamps installed in the nose. Note that the conventional lights have a considerably higher power demand over those with LED technology. In case of generator or battery malfunction ("Gen" or "Low Volt" indication on) it is even more essential to switch these lights off in order to preserve electrical power.

Several generations of nose lights exist in service.

Initial fitment consisted of twin 50W halogen lamps. These were superseded by twin LED lamps. LED lamp technology moved quickly and different units are available. LED lamp driver units, embodied in the lamps, can cause radio interference. Passing the lamp supply

cable through and around a graphite ring can prevent this, or suitable distancing of the antenna cable, or changing the lamp type.

Similarly, several options of nav/strobe lamp exist.

Airworld (removable plastic dome over the lamp unit)

AutoGyro (solid moulded unit, denoted 'AutoGyro)

Aveoflash (denoted such – these are certified units, authorised for use at night)

### **9-2.8 Handling and Servicing**

No change to standard aircraft





INTENTIONALLY LEFT BLANK

## 9-3 GPS/Moving Map Systems

### 9-3.1 General

Depending on customer's configuration the gyroplane can be equipped with different GPS/Moving Map Systems as optional equipment.

#### NOTE

**Any moving map system shall be used for reference only and does not replace proper flight planning and constant oversight and awareness.**

### 9-3.2 through 9-3.6

No change to standard aircraft.

### 9-3.7 System Description

Refer to the manufacturer's documentation.

### 9-3.8 Handling and Servicing

Refer to the manufacturer's documentation.



INTENTIONALLY LEFT BLANK

## 9-4 Fire Indication

### 9-4.1 General

Depending on customer's configuration the gyroplane can be equipped with a Fire indicator light to alert the pilot that a certain temperature in the engine compartment has been exceeded (the engine may be on fire). The fire indication circuit consists of a cable routed inside the engine compartment. The cable has two integrated wires separated by an insulation layer. At a defined temperature the insulation layer will melt and the embedded wires close contact.

Engine fire (circuit short-closed, low resistance) will be indicated by a flashing/blinking Fire indicator light in the Warning and Caution Panel. During normal operation (circuit closed, 'normal' resistance) the Fire indicator light will be off. A malfunction of the system (circuit open) is indicated by a constantly lit Fire indication. At power-on the system will perform a lamp test consisting of a series of three flashes.

Indicator Light	System Status
OFF	Normal Operation (normal resistance)
FLASHING	Fire, abnormal temperature (circuit short-closed)
ON	System Malfunction (circuit open)

### 9-4.2 Limitations

No change to standard aircraft.

### 9-4.3 Emergency Procedures

Proceed according to emergency procedure "Smoke and Fire" provided in SECTION 3 for the standard aircraft.

### 9-4.4 through 9-4.9

No change to standard aircraft.

INTENTIONALLY LEFT BLANK

## **9-5 Canopy Indication**

### **9-5.1 General**

Depending on customer's configuration the gyroplane can be equipped with a Canopy indicator light to alarm the pilot that the canopy is not properly locked.

### **9-5.2 Limitations**

No change to standard aircraft.

### **9-5.3 Emergency Procedures**

Proceed according to emergency procedure "Canopy Open in Flight" provided in SECTION 3 for the standard aircraft.

### **9-5.4 through 9-5.6**

No change to standard aircraft

### **9-5.7 System Description**

The Canopy indication is controlled by a proximity switch at the canopy locking handle, activated by a magnet located within the locking lever. If the canopy is not properly locked the 'Canopy' indication will illuminate and the pre-rotator will be deactivated.

### **9-5.8 Handling and Servicing**

In case of faulty indication or flicker have readjustment performed by an authorized maintenance centre.

INTENTIONALLY LEFT BLANK

## 9-6 Stowage Compartment

### 9-6.1 General

Depending on customer configuration the gyroplane can be configured with one or two outboard stowage compartments.

### 9-6.2 Limitations

$V_{NE}$  Never Exceed Speed..... 130 km/h (80mph)

#### NOTE

The Never Exceed Speed  $V_{NE}$  is valid if one or two stowage compartments are installed.

Maximum loading (per compartment)..... 20 kg

Placard (at each compartment):

**NO STEP!**

### 9-6.3 Emergency Procedures

Unchanged

### 9-6.4 Normal Procedures

#### Exterior Check (supplemental)

#### Station 2/3 and 10/11

Attachment .....Checked and secure

Cover.....Closed and tight



### 9-6.5 Performance<sup>3</sup>

Rate of climb, 500 kg, V <sub>Y</sub> , MCP .....	3.1 m/s (600fpm)
Rate of Climb, 450 kg, V <sub>Y</sub> , MCP .....	3.5 m/s (680fpm)
Rate of Climb, 360 kg, V <sub>Y</sub> , MCP .....	5.5 m/s (1070fpm)

### 9-6.6 Weight and Balance

Unchanged

### 9-6.7 System Description

The stowage compartments are made of GFK and can be installed on the LH, RH or on both sides of the fuselage (see illustration below). Each stowage compartment has a sealed cover on the top side which can be opened and safely locked using quick lock fasteners.



### 9-6.8 Handling / Maintenance

Unchanged

<sup>3</sup> Rate of Climb values were identified within noise measurement according to German regulations and may differ from the listed values depending on engine and propeller type.

## 9-7 ELT (Emergency Locator Transmitter)

### 9-7.1 General

Depending on customer's configuration or legal requirements the gyroplane can be equipped with an ELT (Emergency Locator Transmitter) as an option. The ELT sends distress signals on 406 MHz and 121.5 MHz in case of a crash or can be activated manually by means of a remote cockpit switch or at the ELT's front panel. These distress signals are received and processed by COSPAS-SARSAT satellite-based search and rescue (SAR) system and by airborne and ground stations. The system is designed to remain permanently attached to the aircraft.

### 9-7.2 Limitations

No change to standard aircraft.

### 9-7.3 Emergency Procedures

In case of the following events, manually activate the ELT by switching the remote cockpit switch to 'ON':

- Expected crash landing
- Forced landing in hostile terrain (high vegetation, trees, rugged ground)
- Ditching in hostile water (sea state, temperature, off-shore)

Consider to squawk '7700', if transponder is installed and to make an emergency call.

When on ground, inform ATC, any nearby tower or any station via 121.5 MHz or mobile phone about the emergency, if still possible.

### 9-7.4 Normal Procedures

During normal operation, the front panel switch of the ELT transmitter must be in 'ARM' position in order to allow automatic activation (g-sensor). In addition, the ELT can be activated by switching the remote cockpit switch to 'ON'. The red visual indicator will be on.

During road transport, shipment, when the aircraft is parked for a longer period or for maintenance operation, the front panel switch of the ELT should be switched to 'OFF' in order to avoid false alarms.

In case of accidental activation, the ELT can be reset either by switching to 'RESET/TEST' on the Remote Control Panel or switching to 'OFF' on the ELT transmitter.

### 9-7.5 through 9-7.6

No change to standard aircraft

### 9-7.7 System Description

The ELT installation consists of the following components

- ELT transmitter with visual indicator and mounting bracket
- ELT antenna
- Remote cockpit switch with visual indicator

The ELT transmitter is installed below the aft seat and can be accessed through the service cover below the seat cushion. The ELT transmitter is connected to the ELT antenna at the rear part of the rotor mast fairing. A remote cockpit switch with visual indicator is provided in the instrument panel. In order to use the remote cockpit switch or to enable automatic activation, the 3-position toggle switch of the transmitter must be set to 'ARM'.

If ELT is inadvertently activated, use the 'RESET/TEST' position of the rocker switch to stop transmission and reset the unit. The red visual indicator will extinguish when unit is reset.

The ELT system sends distress signals on 406 MHz and 121.5 MHz. The 406 MHz transmission carries digital data which enable the identification of the aircraft in distress and facilitate SAR operation (type of the aircraft, number of passengers, type of emergency). The 406 MHz message is transmitted to the COSPAS-SARSAT satellites and is downloaded to one of the 64 ground stations. The aircraft is located by Doppler effect by the LEO satellites with a precision better than 2 NM (4 km) at any point of the earth.

The 121.5 MHz frequency is no more processed by COSPAS-SARSAT system but is still used by SAR services for homing in the final stage of rescue operations.

In the event of a crash, the ELT activates automatically by means of a g-switch and transmits a sweep tone on 121.5 MHz and the 406 MHz signal.

For further information, please refer to the manufacturer's documentation Note that apart from the initial registration process, recurrent registration may be required.



Remote cockpit switch



ELT transmitter and cockpit switch

### 9-7.8 Handling and Servicing

The ELT transmitter contains a battery with a limited lifetime. See placard and accompanying documentation. For maintenance and testing, please contact your qualified service partner.

## 9-8 Removal/Installation Canopy

### 9-8.1 General

If a flight with another canopy (e.g. summer canopy) is desired or necessary, the following procedure for removal and installation must be followed. Removed canopies must be stored preferably free from humidity and dust. In order to remove or install a canopy, a second briefed person is needed to assist and help to prevent any damage to the gyroplane or the canopy.

#### NOTE

**Comply with para 4.21 when flying with the summer canopy fitted comply.**

Removal of a canopy:

1. Unlock and open canopy, remove retaining strap from canopy
2. Close canopy, remove retaining washer from hinge pin, remove forward and aft hinge pin
3. Remove canopy, store canopy free from humidity and dust.

Installation of a canopy:

1. Place canopy on gyroplane
2. Insert forward and aft canopy hinges with poly washers, fix with new self-locking nuts, secure with retaining washer (see figure)

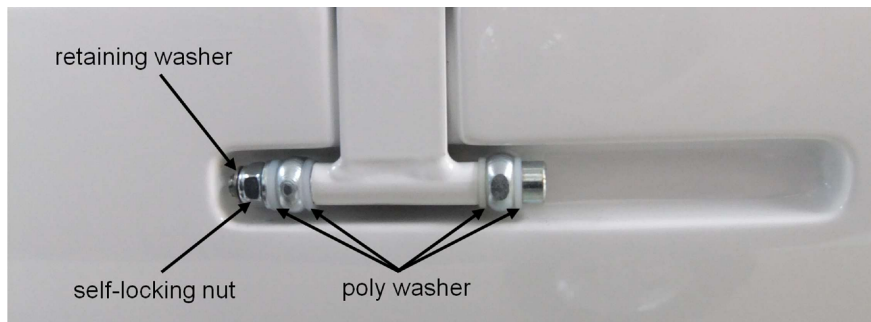

3. Open canopy, install retaining strap to canopy using Loctite 243, close and lock canopy
4. Check that the latch secures properly before flight operation. Adjustment shims are available if required.

### 9-8.2 Limitations

No change to standard aircraft

### **9-8.3 Emergency Procedures**

No change to standard aircraft

### **9-8.4 Normal Procedures**

No change to standard aircraft

### **9-8.5 Performance**

In section 5 (flight performance), flight characteristics can be affected negatively with the summer canopy – primarily due to the increased interior winds, blowing loose articles around and windy conditions for the rear seat occupant.

### **9-8.6 Weight and Balance**

No change to standard aircraft

### **9-8.7 System Description**

No change to standard aircraft

### **9-8.8 Handling and Servicing**

No change to standard aircraft

## CONTENTS

Low-G Avoidance.....	10-1
Side Slip in Gyroplanes.....	10-1
Flying Low on Fuel Is Dangerous.....	10-2
Do Not Push the Envelope and Remain Easy On the Controls.....	10-2
Strobe Lights On – For Your Own and Other’s Safety.....	10-2
Propellers and Rotors Can Be Extremely Dangerous.....	10-2
Power Lines and Cables Are Deadly.....	10-2
Loss of Visibility Can Be Fatal.....	10-2
Overconfidence Prevails in Accidents.....	10-3
Flying Low over Water is Very Hazardous.....	10-3
Conversion Pilots Constitute High Risk When Flying Gyroplanes.....	10-3
Beware of Demonstration or Initial Training Flights.....	10-4
Training Off-Field Simulated Engine Failures.....	10-4

INTENTIONALLY LEFT BLANK

## SECTION 10 - SAFETY TIPS

### General

This section provides miscellaneous suggestions and guidance to help the pilot operate the gyroplane more safely.

### Low-G Avoidance

Never push the control stick forward to descend or to terminate a pull-up (as you would in an airplane). This may produce a low-G (near weightless) condition which can result in a situation with reduced or lost lateral roll control and significant loss of main rotor RPM. Always reduce power to initiate a descent.

### Side Slip in Gyroplanes

Excessive side slip has to be avoided at all means. Side slip can be safely performed up to the degree which is necessary for proper runway alignment for landing within crosswind limitations. Excessive side slip starts at a point where de-stabilizing effects of the fuselage balance out or even supersede the stabilizing effects of the stabilizer. Pilots being new to gyroplanes, especially those with fixed wing experience may not be aware of these physical limitations. When exceeding these limitations, be it by imitating 'professionals' or applying habits and control schemes from fixed wing aircraft, the gyroplane may enter an attitude where it is not recoverable any more. As the pedal control is rather sensitive and alignment is crucial in high-performing gyroplanes, pilots should develop a feeling for side slip and 'automatized feet' in order to maintain aerodynamic alignment and to compensate for power-induced yaw couplings by anticipation as a conditioned reflex.

**A note to training facilities and flight instructors:** Due to their reduced directional stability, gyroplanes require active control to enter, stabilize and neutralize side slip. Most students perceive natural discomfort in side slip. Depending on the situation, students may erroneously make a wrong control input or freeze, especially when over-challenged, stressed, or surprised by the situation. In our opinion flight training should focus on the necessity of correct alignment, the training of recovery procedures, and the development of the right reflexes. Intentional side slip training as a normal procedure is considered to be critical as there is no instrument to indicate 'safe' boundaries. An experienced pilot may tell from an imminent change in control response when limits are approached. A student, however, may unknowingly or inadvertently overshoot the limits, especially when he is overly focussed on the touch-down zone and coming in too high.

Side slip may be performed as a part of the emergency training only, and within safe boundaries. The student must be briefed

- to use gentle pedal input for initiation and stabilization
- initiate side slip at or below 90 km/h (55mph) and maintain air speed by using his perception of speed, and speed sensation (noting that the air speed indicator will give a false indication in a side slip due the angle of the pitot tube to the oncoming airflow)
- not to rely on airspeed indication in side slip
- never to perform abrupt control stick input into the direction of motion (to chase a faulty speed indication)

It is highly advisable that the instructor remains light on the controls at all times.



## **Flying Low on Fuel Is Dangerous**

Never intentionally allow the fuel level to become critically low. Although a gyroplane leaves much more options than a fixed wing aircraft and is easier to control during power-off than a helicopter, a forced landing into unknown terrain always poses unnecessary and unpredictable risk with danger to material, health, or life.

## **Do Not Push the Envelope and Remain Easy On the Controls**

Avoid abrupt control inputs or accelerated manoeuvres, particularly at high speed. These produce high fatigue loads in the dynamic components and could cause a premature and catastrophic failure of a critical component.

## **Strobe Lights On – For Your Own and Other’s Safety**

Turn the strobe lights (if installed) on before starting the engine and leave it on until the rotor stops turning. The strobe lights are located near the propeller and provide a warning to ground personnel. Leaving them on in flight is also advisable since the gyroplane may be difficult for other aircraft to see.

## **Propellers and Rotors Can Be Extremely Dangerous**

Never attempt to start the engine until the area around the propeller is completely clear of any persons or objects. Do not start the engine while standing beside the aircraft as you will easily be struck by the propeller in case of a brake failure or an operating error.

Be sure ground personnel or onlookers don't walk into the propeller or main rotor. Mind the spinning rotor and propeller when taxiing close to obstructions or persons. It is advisable to maintain at least one rotor diameter distance from obstructions or persons when taxiing with spinning rotor. A fast turning rotor is almost invisible, but may contain enough energy to kill a person.

Never let go of the control stick and make sure the rotor blades spin down in level/horizontal attitude until the rotor is at a complete stop. Wind or negligent behaviour on the control stick may cause the blades to flap dangerously low and hit control stops, stabilizer, or people.

## **Power Lines and Cables Are Deadly**

Flying into wires, cables, and other objects is by far the number one cause of fatal accidents in rotary wing aircraft. Pilots must constantly be on the alert for this very real hazard.

- Watch for the towers; you will not see the wires in time
- Fly directly over the towers when crossing power lines
- Allow for the smaller, usually invisible, grounding wire(s) which are well above the larger more visible wires
- Constantly scan the higher terrain on either side of your flight path for towers
- Always maintain at least 500 feet AGL except during take-off and landing. By always flying above 500 feet AGL

## **Loss of Visibility Can Be Fatal**

Flying a gyroplane in obscured visibility due to fog, snow, low ceiling, or even a dark night can be fatal. Gyroplanes have less inherent stability and much faster roll and pitch rates than airplanes. Loss of the pilot's outside visual references, even for a moment, can result in disorientation, wrong control inputs, and an uncontrolled crash. This type of situation is

likely to occur when a pilot attempts to fly through a partially obscured area and realizes too late that he is losing visibility. He loses control of the gyroplane when he attempts a turn to regain visibility but is unable to complete the turn without visual references.

You must take corrective action before visibility is lost! Remember, a precautionary landing in a gyroplane will always be safer than a flight with impaired or no visibility.

### **Overconfidence Prevails in Accidents**

A personal trait most often found in pilots having serious accidents is overconfidence. High-time fixed-wing pilots converting to gyroplanes and private owners are particularly susceptible. Airplane pilots feel confident and relaxed in the air, but have not yet developed the control feel, coordination, and sensitivity demanded by a gyroplane. Private owners must depend on self-discipline, which is sometimes forgotten. When flown properly and conservatively, gyroplanes are potentially the safest aircraft built. But especially gyroplanes also allow little tolerance when flown to their limits. Gyroplanes must always be flown defensively.

### **Flying Low over Water is Very Hazardous**

Accidents repeatedly occur while manoeuvring low over water. Many pilots do not realize their loss of depth perception when flying over water. Flying over calm glassy water is particularly dangerous, but even choppy water, with its constantly varying surface, interferes with normal depth perception and may cause a pilot to misjudge his height above the water.

MAINTAIN SAFETY ALTITUDE AT ALL TIMES

### **Conversion Pilots Constitute High Risk When Flying Gyroplanes**

There have been a number of fatal accidents involving experienced pilots who have many hours in airplanes or helicopters but with only limited experience flying gyroplanes.

The ingrained reactions and habits of an experienced airplane pilot can be deadly when flying a gyroplane. The airplane pilot may fly the gyroplane well when doing normal manoeuvres under ordinary conditions when there is time to think about the proper control response. But when required to react suddenly under unexpected circumstances, he may revert to his airplane reactions and commit a fatal error. Under those conditions, his hands and feet move purely by reaction without conscious thought. Those reactions may well be based on his greater experience, i.e., the reactions developed flying airplanes.

For example, in an airplane his reaction to an engine failure would be to immediately and considerably go forward with the stick or horn. In a gyroplane, application of inadequate forward stick could result in a low-G situation or, if the engine failure occurred during initial climb, a reduction of rotor RPM combined with a high sink rate with the consequence of a hard landing or impact.

Airplane pilots may also underestimate pedal work. Especially in a gyroplane, pedal control is most critical as it has the highest rate response with the smallest static and dynamic damping effect of all other controls. On top of that, power-yaw coupling is much more predominant than in an airplane. Being used to the high directional stability of an airplane, a conversion pilot may neglect proper pedal work and, which is much worse, assume side slip limits at the pedal stop. Very much like helicopters, gyroplanes cannot be flown by control position or control force, but solely by resulting attitude. That means that the pilot together

with his built-in senses and programmed reflexes represents a vital part in the active control feedback loop.

Helicopter pilots, on the other hand, may underestimate the characteristics of gyroplanes and the necessity for proper training. The simplicity of design may lead them to the assumption that gyroplanes are easy to fly throughout the envelope. Even helicopter pilots that do not 'look down' on gyroplanes and take it serious may confuse throttle control (push for power) with the control sense of a collective pitch (pull for power) in a stress situation.

To develop safe gyroplane reactions, conversion pilots must practice each procedure over and over again with a competent instructor until hands and feet will always make the right move without requiring conscious thought. AND, ABOVE ALL, HE MUST NEVER ABRUPTLY PUSH THE CONTROL STICK FORWARD.

### **Beware of Demonstration or Initial Training Flights**

A disproportionate number of fatal and non-fatal accidents occur during demonstration or initial training flights. The accidents occur because individuals other than the pilot are allowed to manipulate the controls without being properly prepared or indoctrinated.

If a student begins to lose control of the aircraft, an experienced flight instructor can easily regain control provided the student does not make any large or abrupt control movements. If, however, the student becomes momentarily confused and makes a sudden large control input in the wrong direction, even the most experienced instructor may not be able to recover control. Instructors are usually prepared to handle the situation where the student loses control and does nothing, but they are seldom prepared for the student who loses control and does the wrong thing.

Before allowing someone to touch the controls of the aircraft, they must be thoroughly indoctrinated concerning the sensitivity of the controls in a gyroplane. They must be firmly instructed to never make a large or sudden movement with the controls. And, the pilot-in-command must be prepared to instantly grip the controls should the student start to make a wrong move.

### **Training Off-Field Simulated Engine Failures**

**Pilots:** Besides legal aspects, never train off-field simulated engine failures on your own!

**Instructors:** Always check an area for wires or other obstructions before simulating engine failures. Consider go-around path and the suitability for an actual engine off touch-down. Cut the throttle smoothly and keep control of engine idle RPM to avoid actual engine starvation.

## APPENDIX

### LIST OF APPENDICES

Operator Registration Form  
Customer Feedback Form  
Incident Reporting Form

INTENTIONALLY LEFT BLANK



<p>Use this form to register as (new) operator / owner, in order to receive safety and service related information concerning your aircraft. The information is stored in a database and is only used within AutoGyro GmbH for the above purpose.</p> <p>Without proper and timely registration, the operator will not receive vital information, which may lead to unsafe flight or an un-airworthy aircraft.</p>		
<p>Return this form to: AutoGyro GmbH Dornierstraße 14 31137 Hildesheim or E-Mail to <a href="mailto:info@auto-gyro.com">info@auto-gyro.com</a></p>		
Aircraft Type:	Serial Number (Werk-Nr.):	Registered at: (Airworthiness authority)
Registration / Call Sign: curr./new: _____ previous:	Year of manufacture:	Engine Type:
Airframe S/N:	Rotor System S/N:	Engine S/N:
Airframe hours:	Rotor System hours:	Engine hours:
<p>Previous Owner (if applicable) - please state name, full address, phone and E-Mail</p> <p style="text-align: right;">Signature and Date</p>		
<p>New/current Owner - please state name, full address, phone and E-Mail</p> <p>E-Mail</p> <p style="text-align: right;">Signature and Date</p>		
<i>Below fields are used for AutoGyro internal processing – do not fill in!</i>		
Data entered onto database (by / when)	Acknowledgement sent (date) (by / when)	



<p>Customer's feedback is important to AutoGyro's Technical Publication team.</p> <p>This manual and all information herein have been compiled with greatest care and a maximum level of clarity, safety, and user-friendliness in mind. However, we welcome any comments, questions or suggestions that help us provide a higher quality of our documentation, services, and products.</p> <p>All submitted feedback forms will be processed internally. We are committed to providing a response within ten working days of receipt.</p>		
<p>Return this form to: AutoGyro GmbH Dornierstraße 14 31137 Hildesheim    or E-Mail to <a href="mailto:info@auto-gyro.com">info@auto-gyro.com</a></p>		
Document	Issue/Version	Page / Chapter
Product - specify type, year of manufacturing, and serial number ( if applicable)		
Other subject		
Your feedback or error reporting - use extra sheets if needed and include a suggestion for correction or remedial action, if possible		
Reported by		
E-Mail		Date
<i>Below fields are used for AutoGyro internal processing – do not fill in!</i>		
Investigation completed	Action and response	Internal reference



<p>This form is supplied to enable the owner/operator to inform (anonymously, if needed) AutoGyro GmbH of any incident, accident, or other field or service failure that they feel appropriate. The owner must also, of course, inform the relevant authorities if that is appropriate, e.g. Air Accident Investigation Branch etc.</p> <p>Depending on the incident information supplied, a corrective action is investigated and, if needed, supplied back to the customer(s).</p> <p>The information is stored in a database and is only used within AutoGyro GmbH for the above purpose.</p>		
<p>Return this form to: AutoGyro GmbH Dornierstraße 14 31137 Hildesheim    or E-Mail to <a href="mailto:info@auto-gyro.com">info@auto-gyro.com</a></p>		
Aircraft Type:	Serial Number (Werk-Nr.):	Registered at: (Airworthiness authority)
Registration / Call Sign:	Year of manufacture:	Engine Type:
Airframe S/N:	Rotor System S/N:	Engine S/N:
Airframe hours:	Rotor System hours:	Engine hours:
<p>Description of incident (be as precise as possible and use extra sheets if needed)</p>		
<p>Incident reported by (information is only stored for further inquiry and deleted after investigation)</p>		
E-Mail	Signature and Date	
<p><i>Below fields are used for AutoGyro internal processing – do not fill in!</i></p>		
Investigation completed	Corrective action	Internal reference





[www.auto-gyro.com](http://www.auto-gyro.com)

**AutoGyro GmbH**  
Dornierstrasse 14  
31137 Hildesheim  
Germany

Phone +49 (0) 5121 / 880 56-00  
[info@auto-gyro.com](mailto:info@auto-gyro.com)  
[www.auto-gyro.com](http://www.auto-gyro.com)